



Generating optimal performance, powered by DuPont.

For decades, innovative technologies from DuPont have purified water needed to power communities worldwide.

SEE HOW

**Coal Fired
Power Plant**



**Natural Gas
Power Plant**

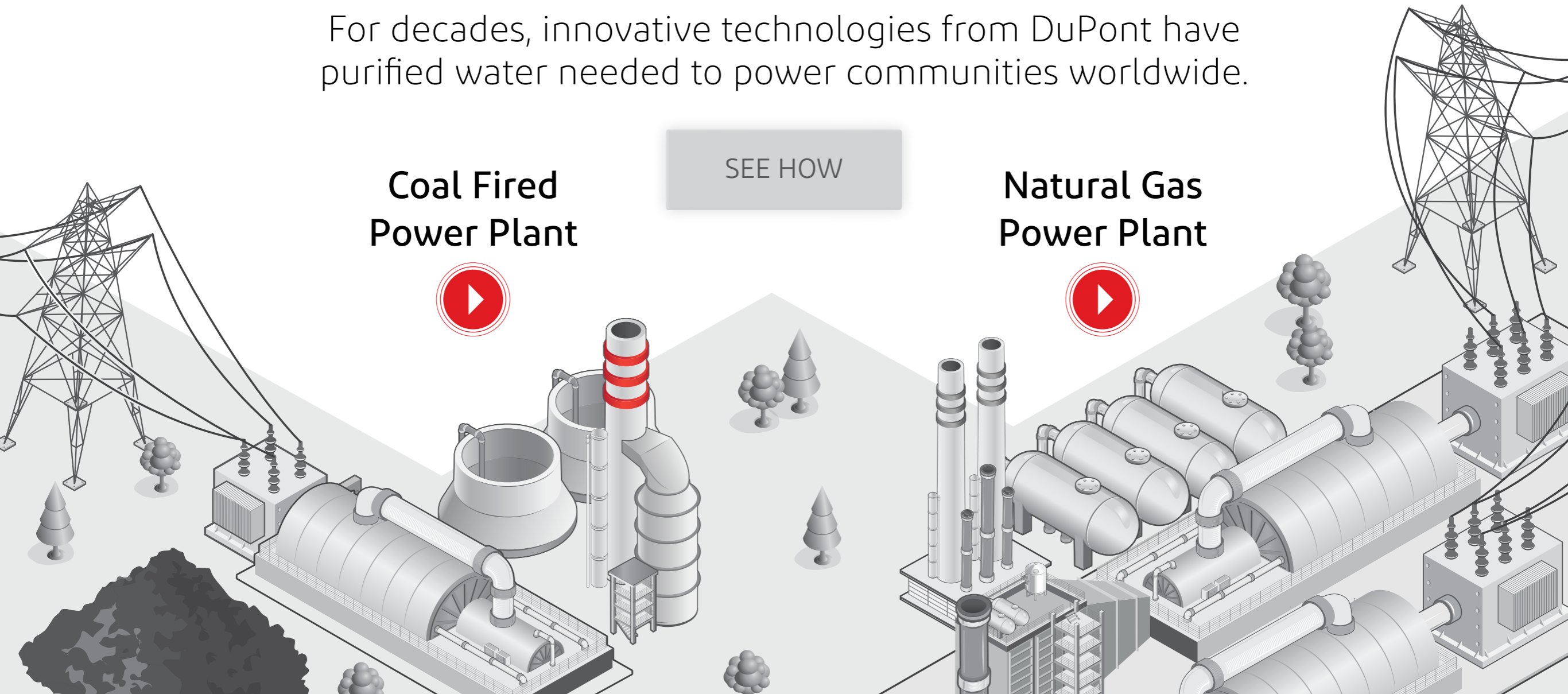

COAL FIRED POWER PLANT

NATURAL GAS POWER PLANT



FOSSIL POWER PLANT WATER TREATMENT

THE CHALLENGE



Today, challenges in generating power are growing along with the demand. More than ever, power plants need optimized and cost effective solutions to meet their water treatment needs, prolonging operational and equipment life and preventing corrosion, maintenance and enabling uninterrupted operation.

THE SOLUTION



DuPont is helping to ensure reliable operation in power plants of every type. With world-class innovation and quality in water treatment technologies, along with local expertise and global experience, we offer products that can help protect your assets, increase efficiencies and keep your plant running optimally. We work closely with utilities, service providers and equipment manufacturers to provide integrated solutions in all of the water treatment applications found in fossil driven power plants.

BACK



The power of water.

For decades, innovative technologies from DuPont have purified water used throughout coal-fired power plants.

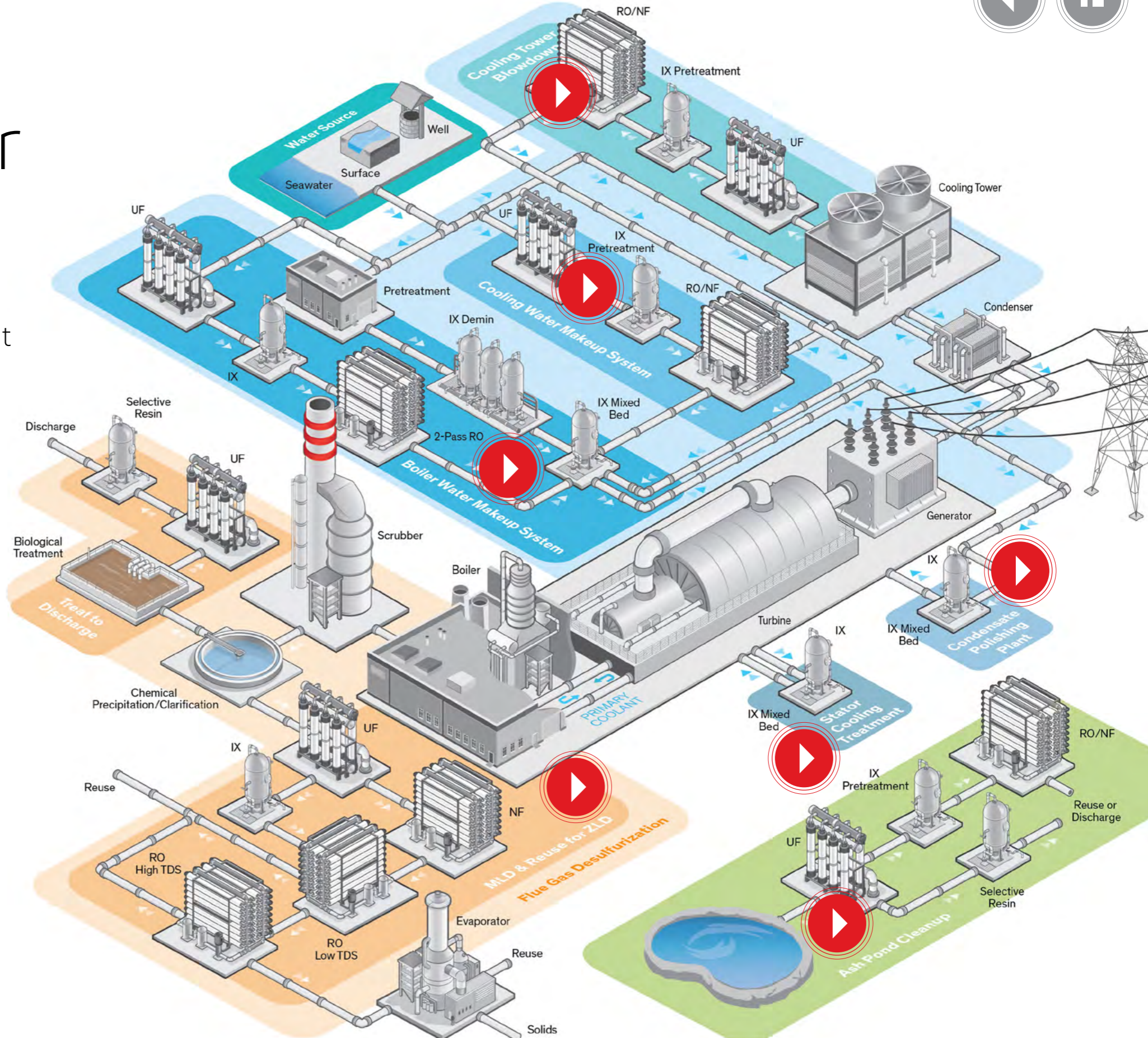

BOILER WATER MAKEUP

Boiler alert.

Reduce downtime and save money, no matter the water source or pressure requirements.

SEE HOW

COMMON DESIGNS

RECOMMENDED PRODUCTS

Click on technologies to better understand their role in makeup water treatment.

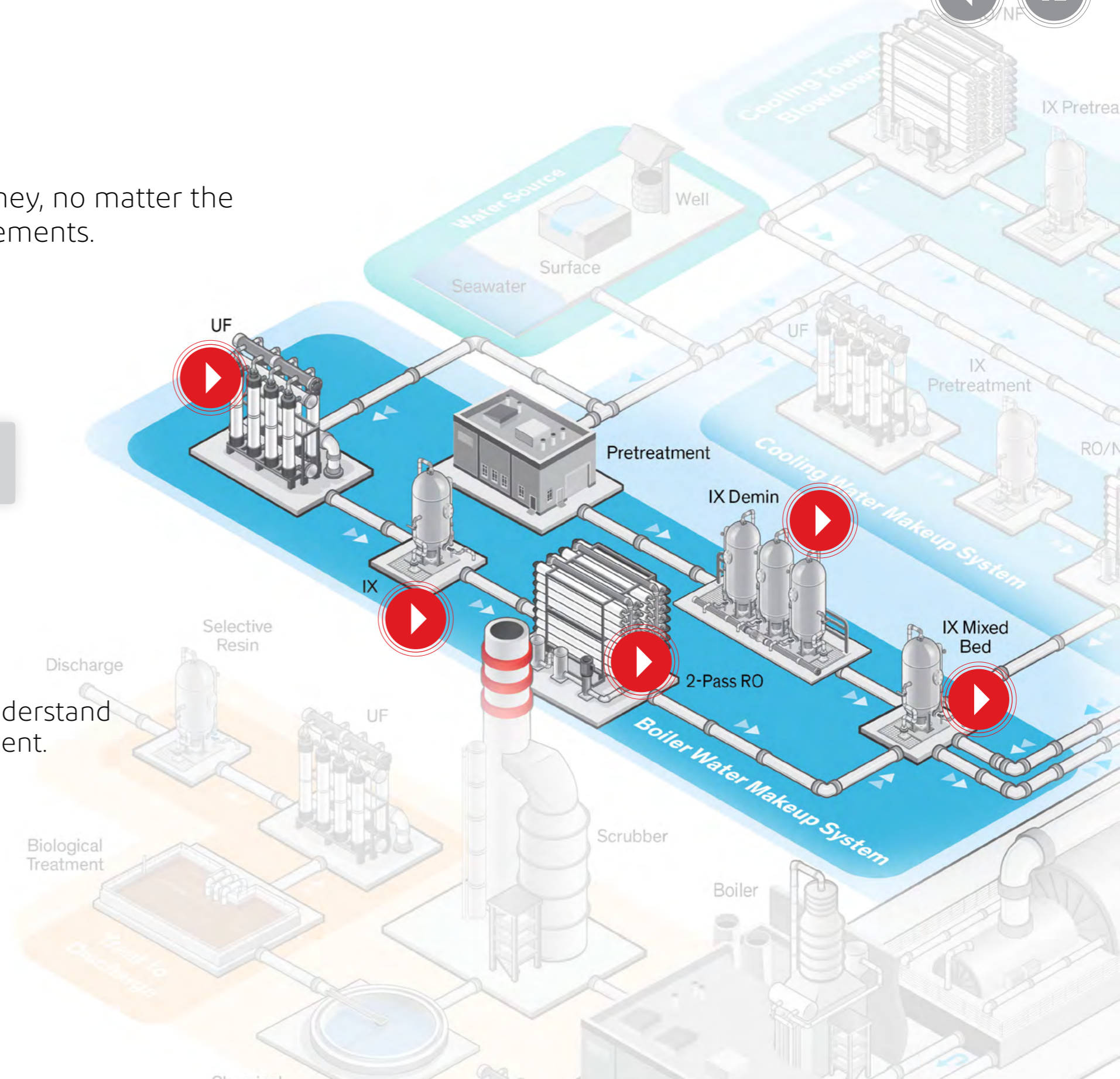



COAL FIRED POWER PLANTS • BOILER WATER MAKEUP

THE CHALLENGE



Fresh makeup water replaces losses from evaporation and blowdown in the steam/condensate loop. Varying feed conditions and boiler demands make operational efficiency difficult to maintain. Depending on the water chemistry employed and operational requirements of the boiler, contaminants must often be maintained at ppb levels to avoid scaling and corrosion. Over time, as power plant designs have been upgraded for higher efficiency, the metallurgies and processes used have placed progressively higher demands on makeup water purity.

THE SOLUTION



Treatment steps depend on the required water quality vs. the raw water quality. Regardless of which demineralization technology you prefer, DuPont has you covered. We offer comprehensive solutions for your makeup water challenges that can achieve desired quality levels, leading to optimized water use, reduced asset corrosion and boiler downtime, and ultimately trimmed operational costs.

BACK



BOILER WATER MAKEUP

Common Designs

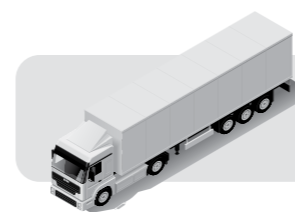

ON-SITE MOBILE DEMINERALIZER

• May contain any of these designs

Multiple process schemes exist utilizing a combination of ultrafiltration, reverse osmosis and ion exchange technologies. Mobile systems incorporating any one of these designs are becoming more common in some regions.

Classical schemes using ion exchange minimize electrical energy and water consumption.

More commonly seen in today's fossil plants, schemes incorporating membranes reduce load on ion exchange resins, minimize chemical consumption and are more adept at handling challenging waters.

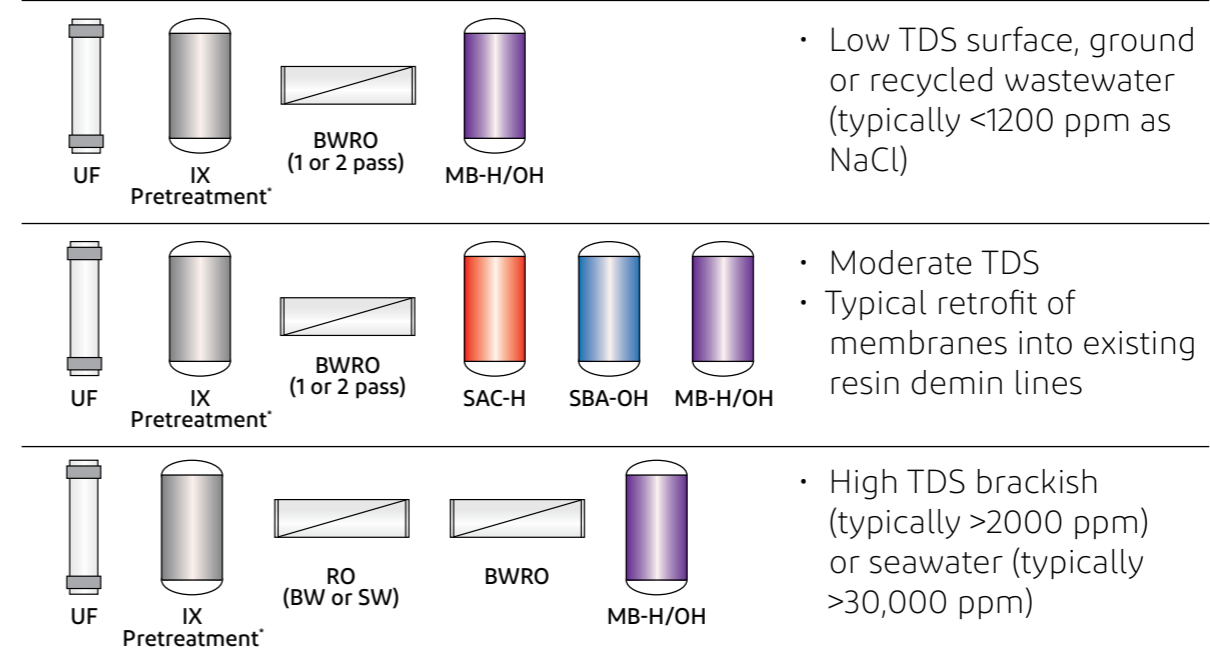
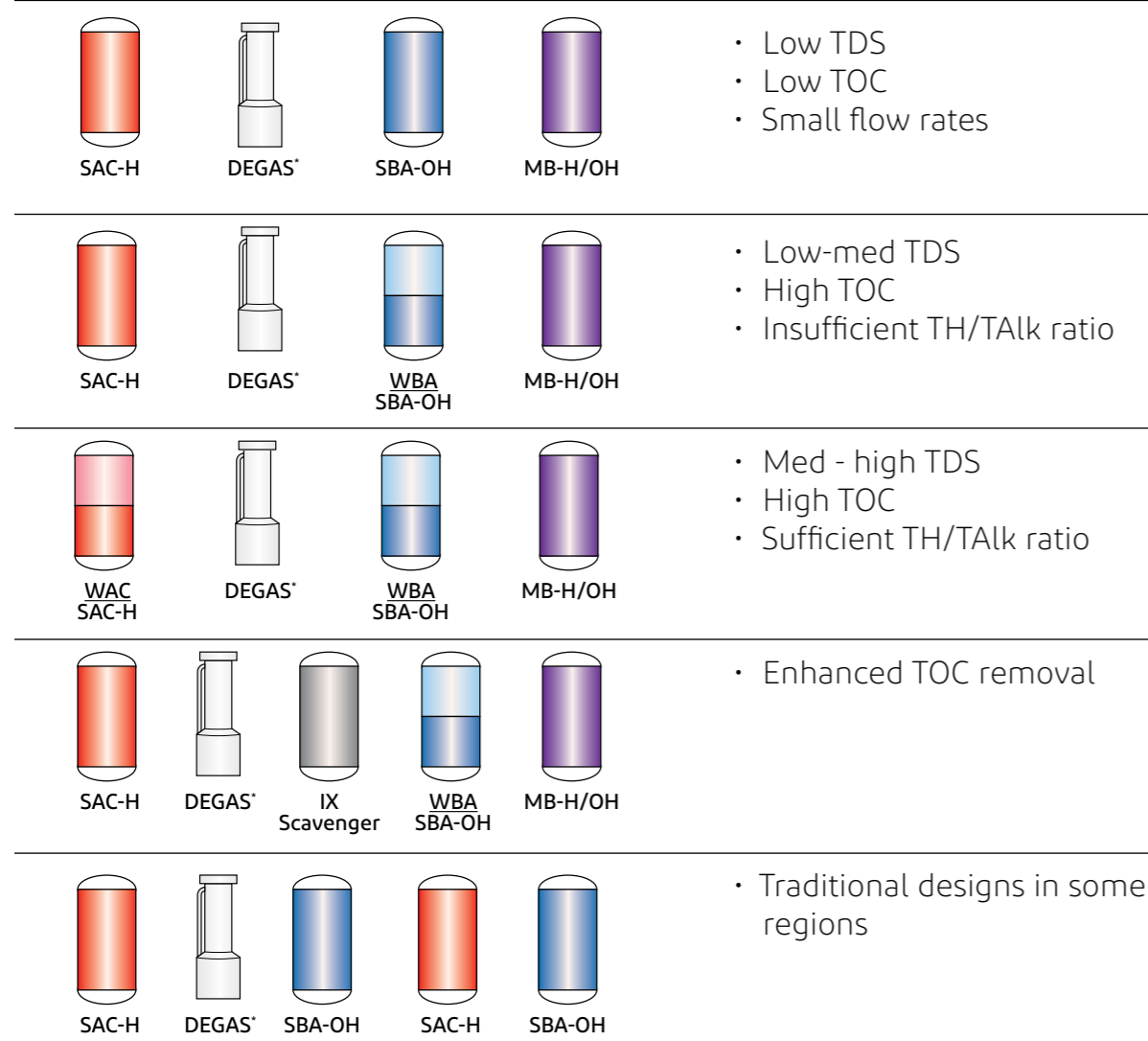

**Optional, dependency on inlet water quality*

**In case of low alkalinity, degasifier tower may be optional*

BACK

CONTACT AN EXPERT

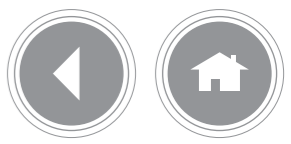

Ion Exchange Demineralization (IX Demin)

Ion Exchange removes all cations, anions, and large organic contaminants. IX demineralization consists of at least two resin beds: a hydrogen form strong acid cation resin followed by a hydroxide form strong base anion resin. A degasifier may be used between them to remove alkalinity. Weak acid cation and/or weak base anion may also be incorporated, depending on levels of TDS, hardness, TOC and alkalinity.

DuPont Unique: The widest range of industry-leading, reliable ion exchange resins from world-class manufacturing facilities.

Benefits:

- Reduce key ionic contaminants down to the microgram per liter concentrations required for steam generation in fossil-fired power plants

The Numbers:

- Save up to 40% in OPEX and receive up to 10x better water quality by using reverse flow beds over conventional co-flow systems
- Further lower cost by 25% using AMBERPACK™ and UPCORE™ packed beds, which use less regenerant and service water

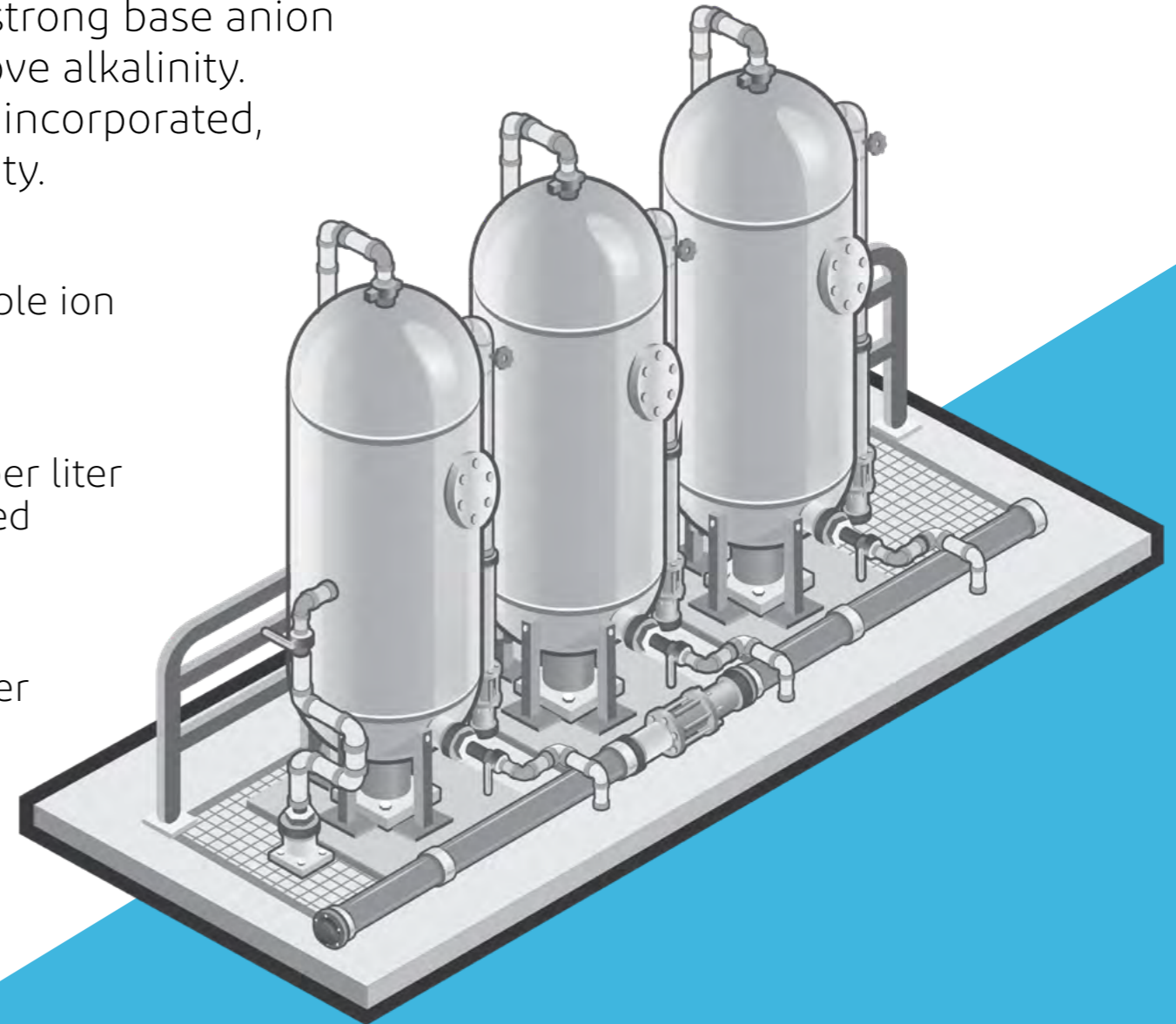
[BACK](#)[RECOMMENDED PRODUCTS](#)

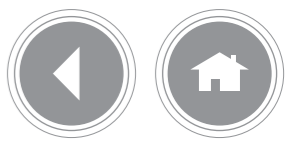

Ultrafiltration (UF)

Ultrafiltration technology removes colloids, particles and bacteria in a continuous system.

DuPont Unique: Provides the market's highest membrane active area, translating to smaller system footprint. All DuPont UF are made with high chemical resistance PVDF that reduces fouling and improves cleaning performance; providing higher system reliability and lower maintenance.

Benefits:

- Prevent or reduce fouling on demineralization unit, ideally used as a pre-treatment for downstream units like RO
- Reduce the impact of poor or highly variable source water on your boiler feedwater management
- Modularized, with a high level of automation and significantly smaller footprint than conventional filtration systems
- High recovery at 90-95%

The Numbers:

- Reduce RO cleaning needs by as much as 50% by using ultrafiltration as a pretreatment

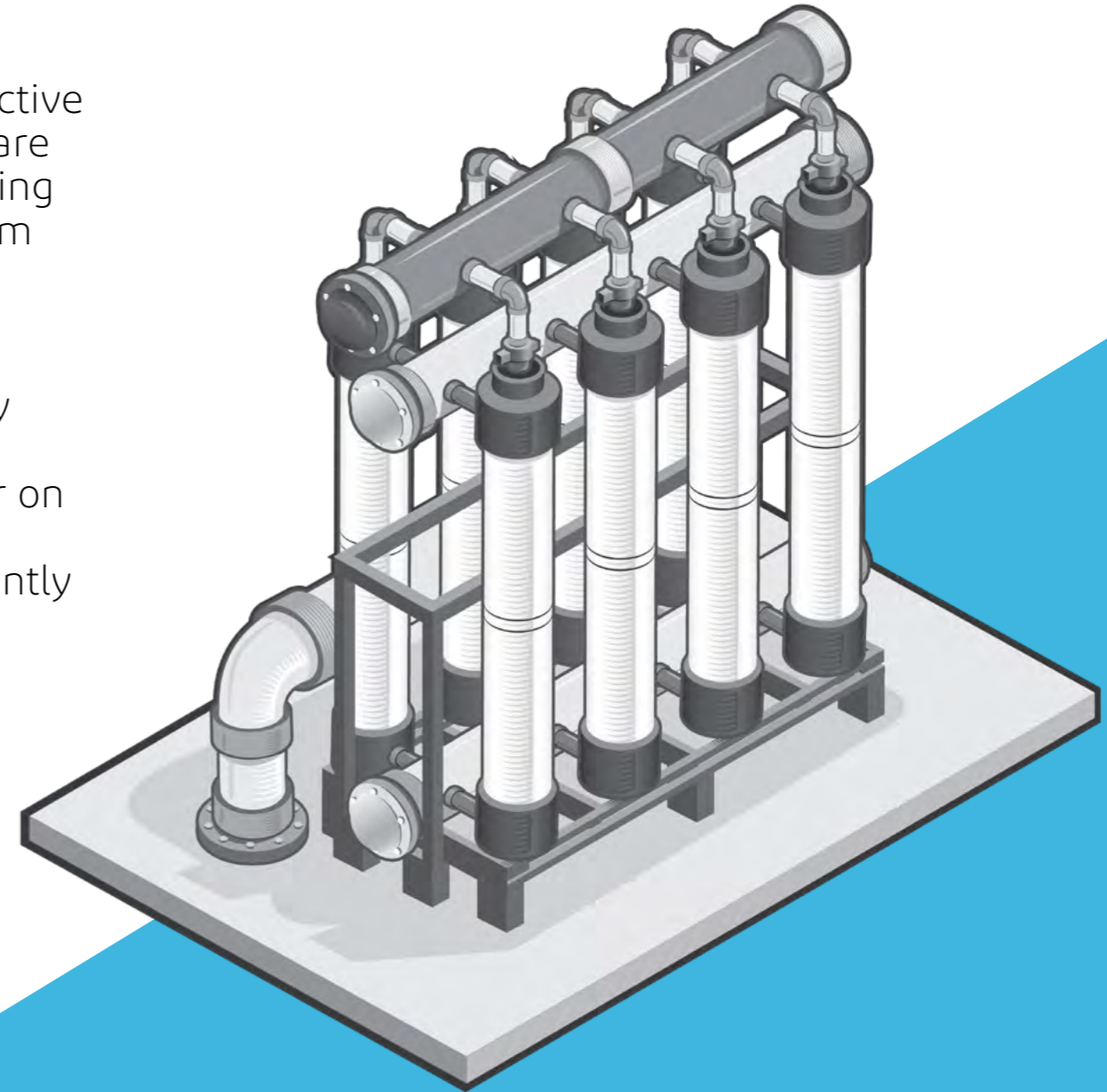
[BACK](#)[RECOMMENDED PRODUCTS](#)

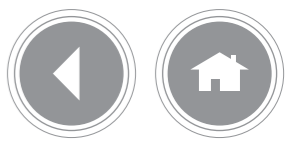

Ion Exchange (IX) Pretreatment

Purification technology that can work in high TDS/contaminant conditions to remove dissolved solids, total organic carbon, and other potential foulants.

DuPont Unique: Recognized world-leading ion exchange brand offers superior strength and quality. DuPont offers a comprehensive range of ion exchange resins to suit the most stringent water purity requirements and operating parameters.

Benefits:

- Prevent scaling in downstream RO and avoid the complication and expense of using antiscalants by incorporating softening resins to remove hardness from makeup water
- Protect RO and/or UF by using strong acid cation resins to help remove certain cationic polymers present from upstream coagulation systems
- Protect downstream softening and RO units with tailored strong base anion scavenging resins that remove certain organic species

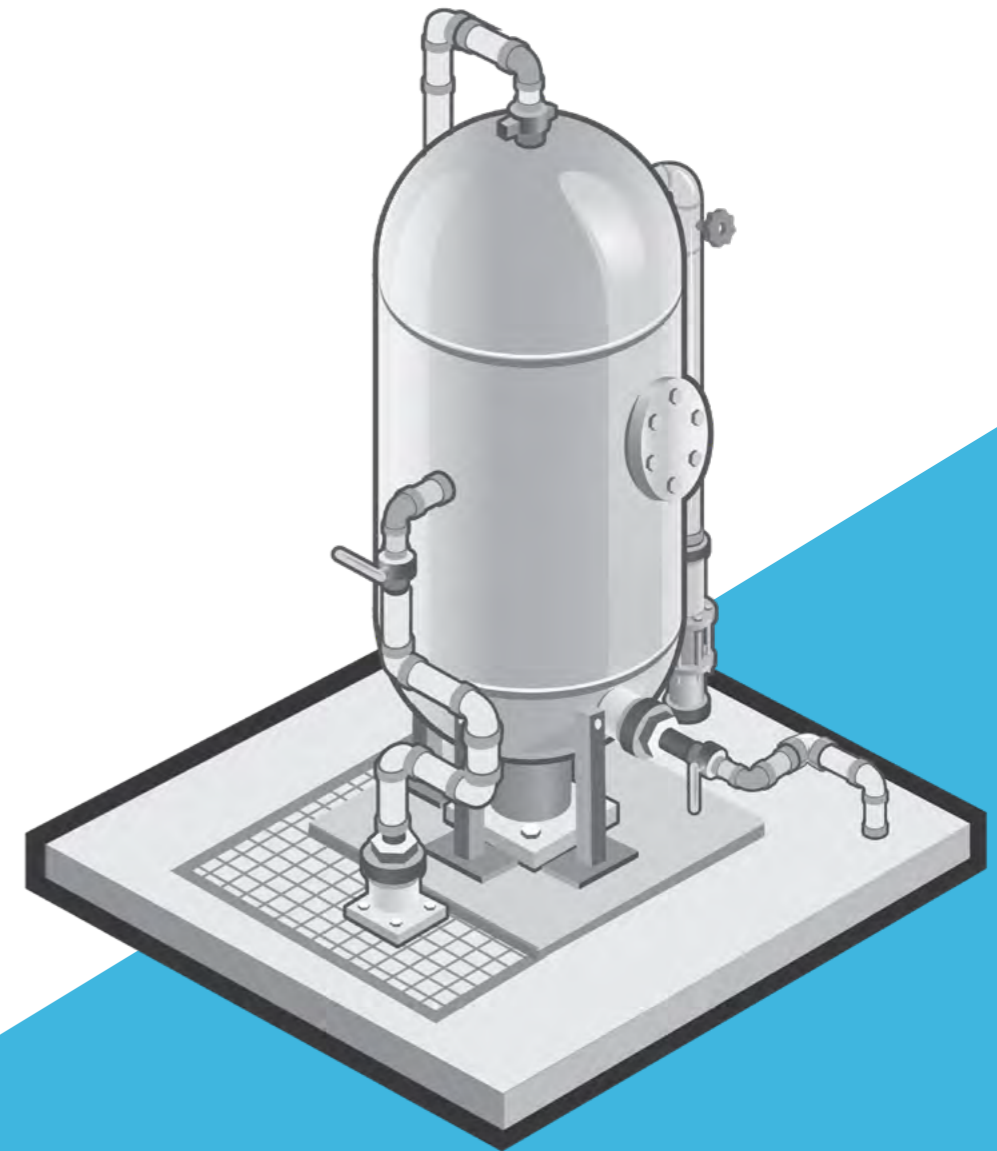
[BACK](#)[RECOMMENDED PRODUCTS](#)

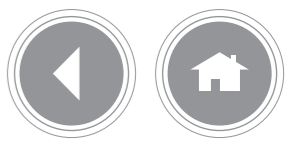

Reverse Osmosis/Nanofiltration (RO/NF)

Pressure driven filtration technology that removes molecules and ions from boiler makeup water. Removes down to a specific ion level (Ca, Mg, Fe, Si, Al).

DuPont Unique: Recognized world leader in RO and NF technologies for demineralizing brackish water or desalinating seawater.

Benefits:

- Prevent or reduce scalants, foulants and ions from entering the steam cycle
- Lower the blowdown rate and reduce total water intake
- Enable use of alternative feedwater sources, such as wastewater, to reduce overall water footprint
- Reduce the impact of poor or highly variable source water on your boiler water management
- Remove silica to reduce regeneration frequency of downstream IX MB

The Numbers:

- Reduce energy costs by over 30% by using high rejection, low energy innovative RO membrane technologies while improving water quality up to 40% against standard RO offerings

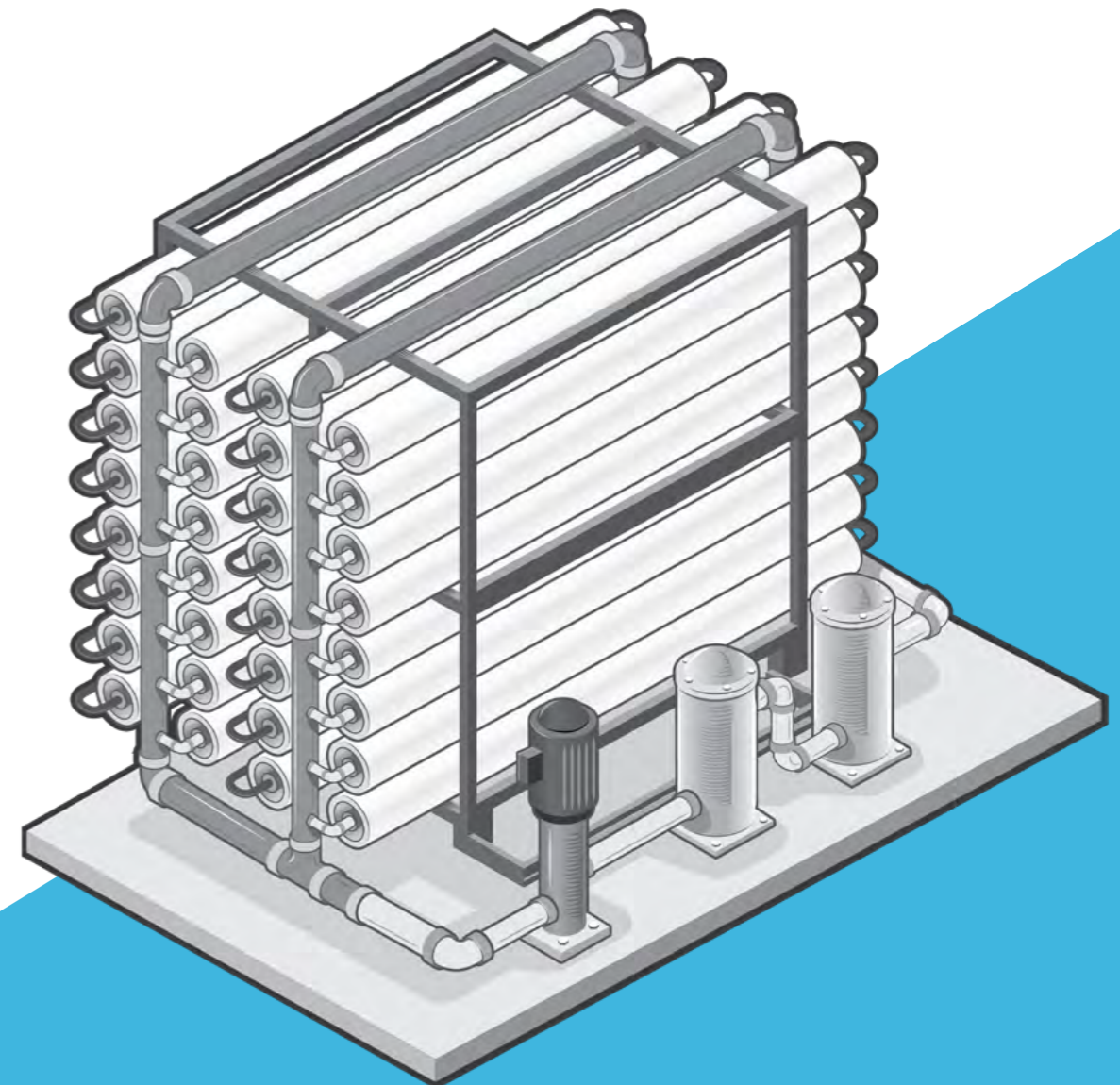
[BACK](#)[RECOMMENDED PRODUCTS](#)

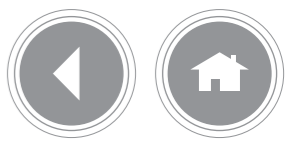

Ion Exchange Mixed Bed (IX MB)

Purification technology ideal to remove residual contaminants typically present in the low ppm to ppb range. IX MB is the standard final polishing step for boiler makeup.

DuPont Unique: A comprehensive range of uniform particle size (UPS) ion exchange resins, recognized for superior strength and quality, to suit the most stringent water purity and operating parameters for working and polishing mixed-beds.

Benefits:

- Great combination of trace contaminant removal, reliability, and cost effectiveness
- Optimize water quality with efficient regeneration and long life when using UPS MB resins with high kinetics and comparatively low pressure drop

The Numbers:

- Lower ionic leakage by 10-50% using UPS MB resins, resulting in longer run lengths (typically 10-30%) and higher water purity than most conventional MB resins

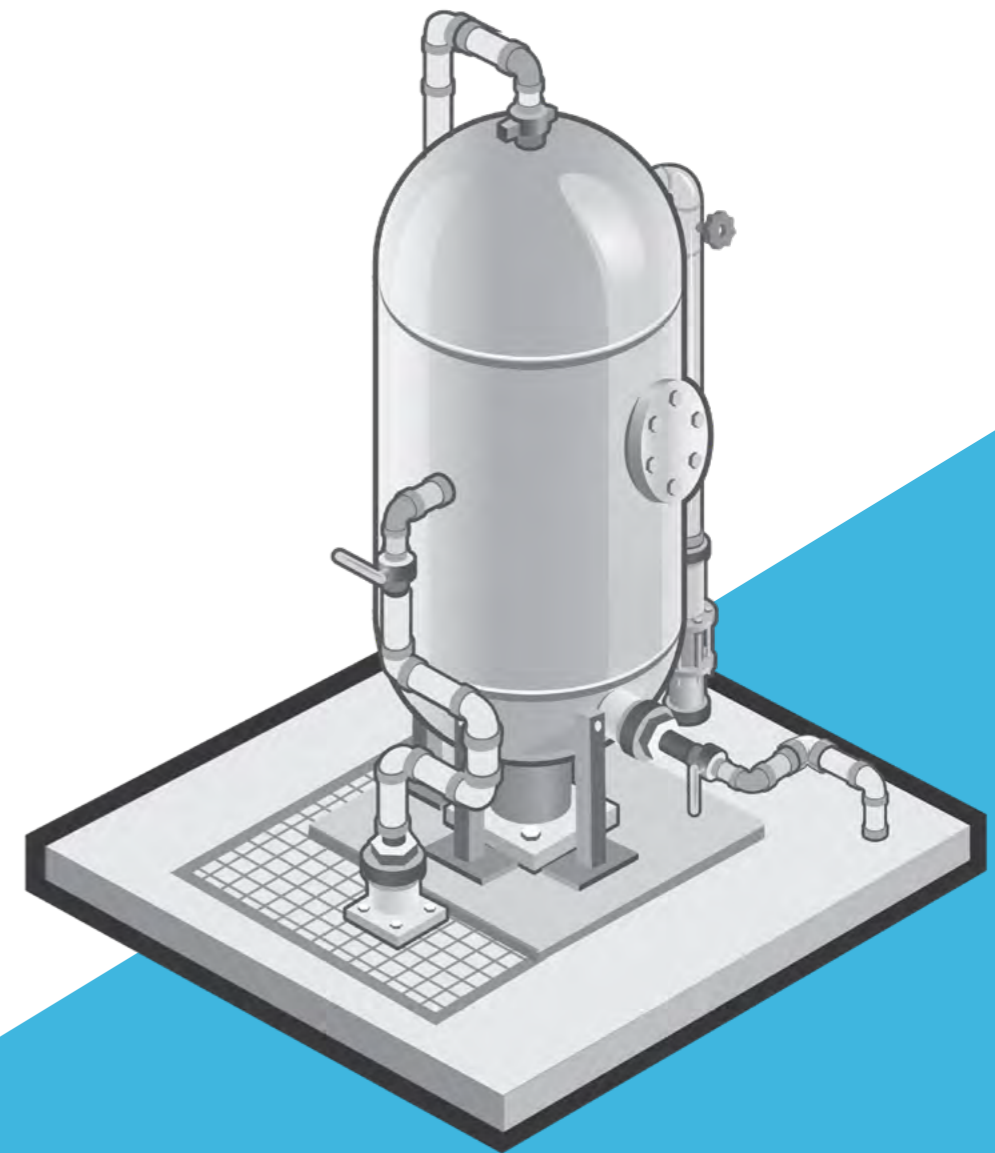
[BACK](#)[RECOMMENDED PRODUCTS](#)



COOLING WATER MAKEUP

The right makeup for any water.

Don't let cooling water limit production. Meet any makeup water challenge with novel and advanced technologies.

SEE HOW

COMMON DESIGNS

RECOMMENDED PRODUCTS

Click on **technologies** to better understand their role in makeup water treatment.

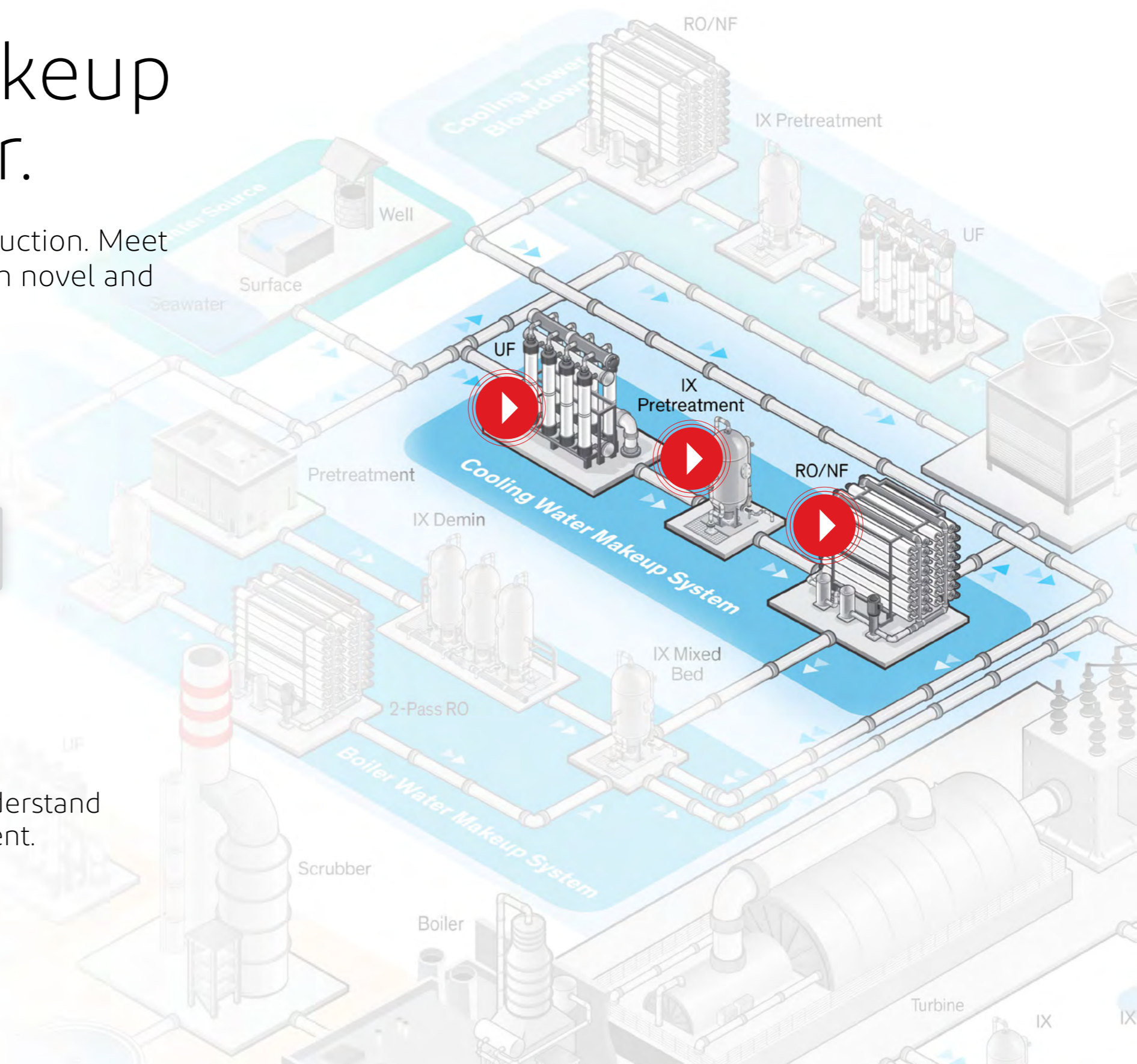



COAL FIRED POWER PLANTS • COOLING WATER MAKEUP

THE CHALLENGE



Cooling tower systems require a constant source of water due to losses from drift, evaporation, and blowdown. Depending on water source, region, and cooling tower type, several advanced filtration technologies and chemistries may be necessary to properly ready the make-up water before entering cooling tower system.

THE SOLUTION



DuPont can help you reduce corrosion, scale, biofouling, and other asset-limiting concerns no matter the fresh water source, abundance of water, and condition. We will work with you to determine an appropriate mix of technologies, including ultrafiltration (UF), reverse osmosis (RO), nanofiltration (NF), and ion exchange (IX).

BACK

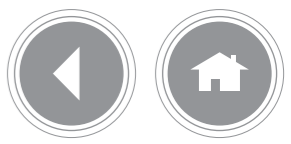

Common Designs

Cooling water makeup treatment is often combined with portions of a boiler makeup system. Designs incorporating ultrafiltration with reverse osmosis enable use of alternative sources, such as wastewater, for this stream.

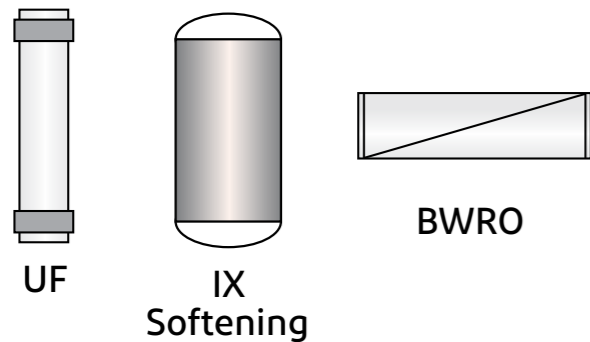

- Reduce cooling tower scale and corrosion
- Reuse of BWRO reject
- Higher RO recovery



- Colloidal and particulate removal

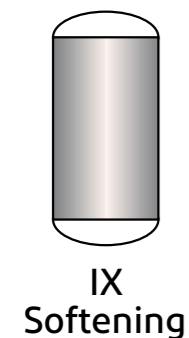

- Reduce cooling tower scale and corrosion



- Reduce cooling tower scale and corrosion

BACK

CONTACT
AN EXPERT

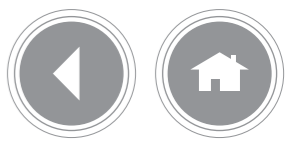

COOLING WATER MAKEUP

Ultrafiltration (UF)

Ultrafiltration technology removes colloids, particles and bacteria in a continuous system.

DuPont Unique: Provides the market's highest membrane active area, translating to smaller system footprint. All DuPont UF are made with high chemical resistance PVDF that reduces fouling and improves cleaning performance; providing higher system reliability and lower maintenance.

Benefits:

- Reduce the impact of poor or highly variable source water on your cooling tower management
- Prevent or reduce fouling on demineralization unit, ideal to be used as a pre-treatment for downstream units like RO
- Modularized, with a high level of automation and significantly smaller footprint than conventional filtration systems
- High recovery at 90-95%

The Numbers:

- Reduce RO cleaning needs by as much as 50% when using ultrafiltration as a pretreatment

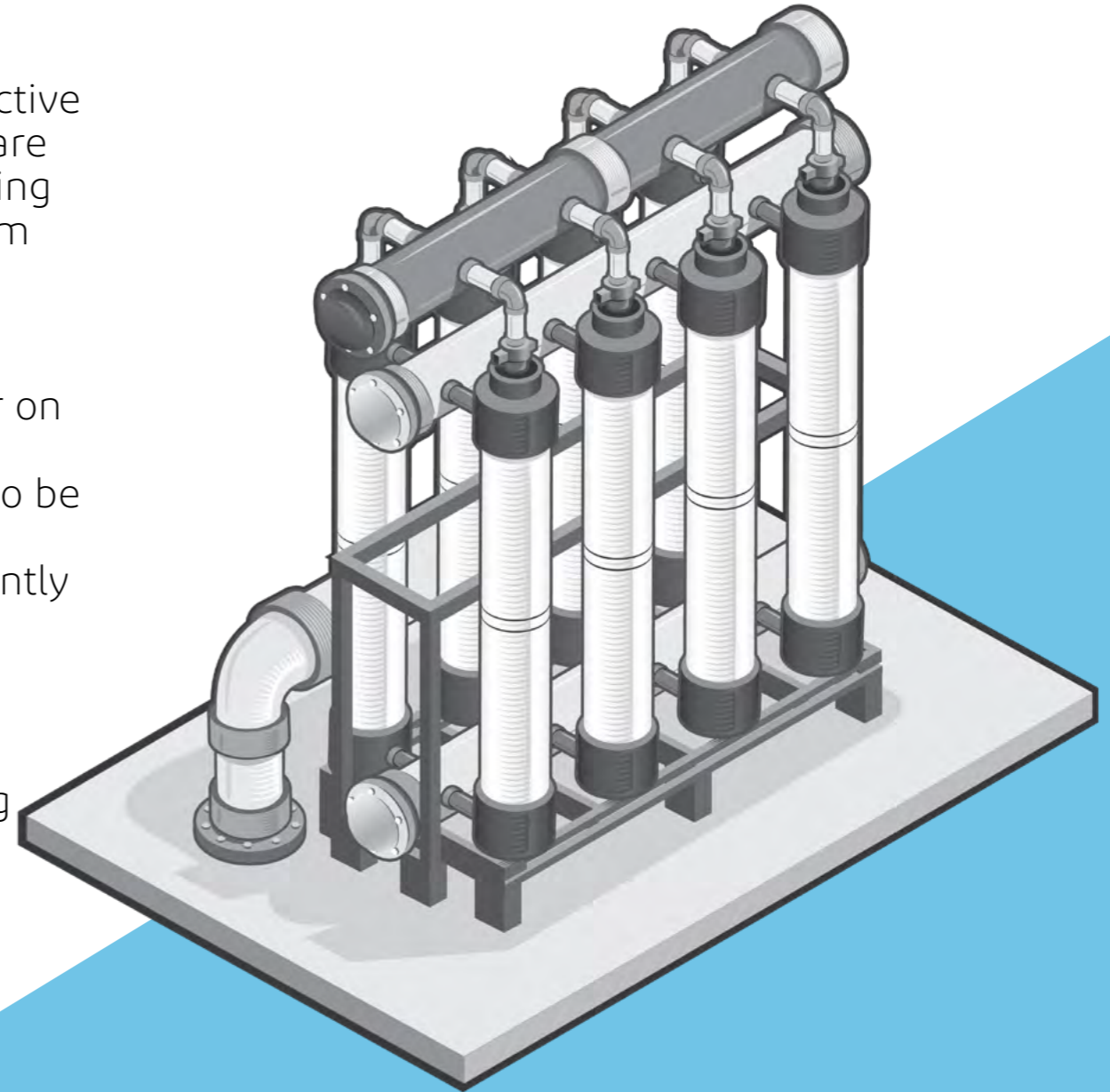
[BACK](#)[RECOMMENDED PRODUCTS](#)



Ion Exchange (IX) Pretreatment

Purification technology that can work in high TDS/contaminant conditions to remove dissolved solids and total organic carbon.

DuPont Unique: Recognized world-leading ion exchange brands offer superior strength and quality. DuPont offers a comprehensive range of ion exchange resins to suit the most stringent water purity requirements and operating parameters.

Benefits:

- Prevent scaling in the cooling tower or downstream RO treatment and avoid the complication and expense of using antiscalants by incorporating softening resins to remove hardness from makeup water
- Strong and weak acid cation industrial softening resins can be tailored to fit your specific needs

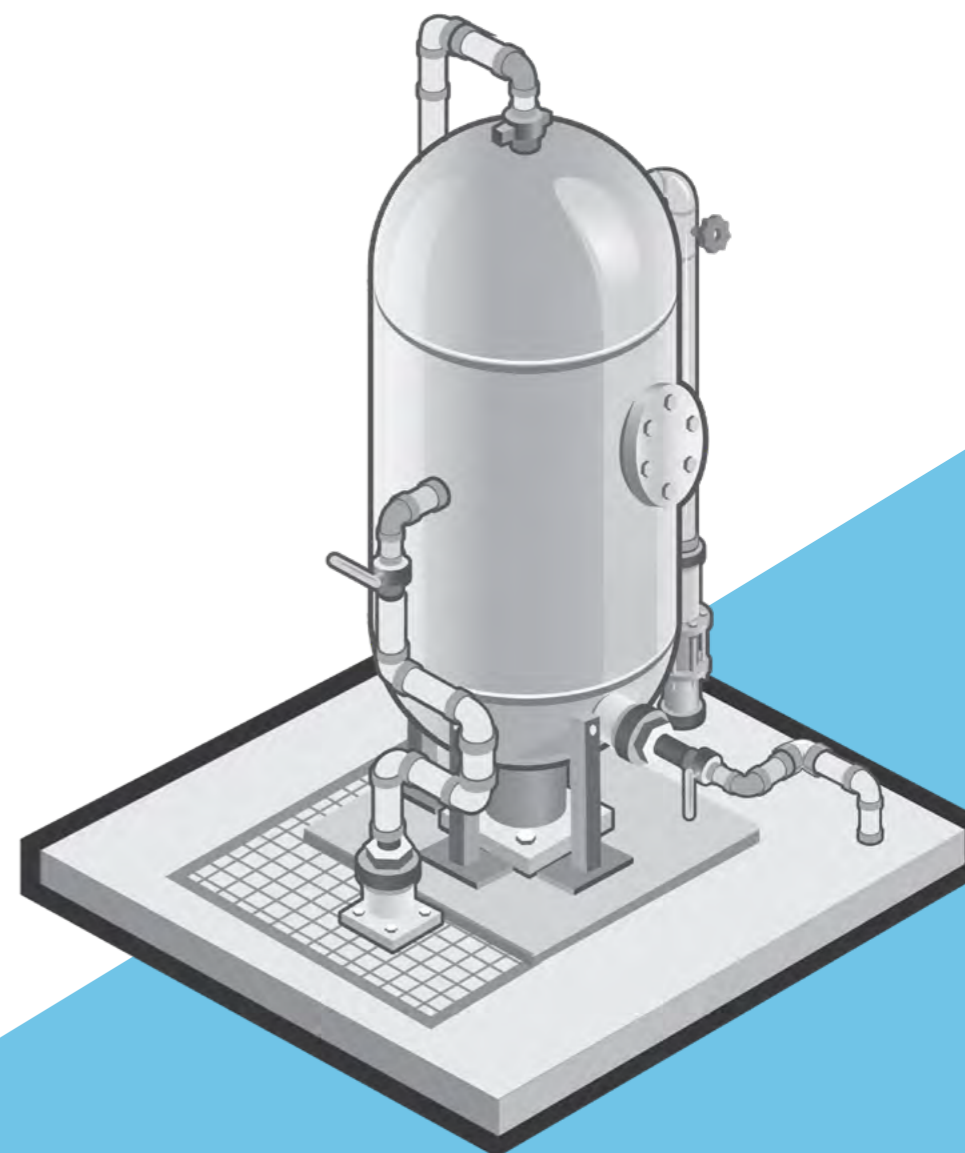
[BACK](#)[RECOMMENDED PRODUCTS](#)



Reverse Osmosis/Nanofiltration (RO/NF)

Filtration technology that can remove many types of molecules and ions, down to a specific ion level (Ca, Mg, Fe, Si, Al).

DuPont Unique: Recognized world leader in RO and NF technologies for demineralizing brackish water or desalinating seawater.

Benefits:

- Prevent or reduce scalants, foulants and ions from entering cooling towers
- Increase number of cycles in cooling tower and reduce water intake
- Enable use of alternative feedwater sources, such as wastewater, to reduce overall water footprint
- Reduce amount of chemicals needed for cooling water control
- Reduce the impact of poor or highly variable source water on your cooling water management

The Numbers:

- Save 20-60% in water intake by recirculating your cooling tower twice as often

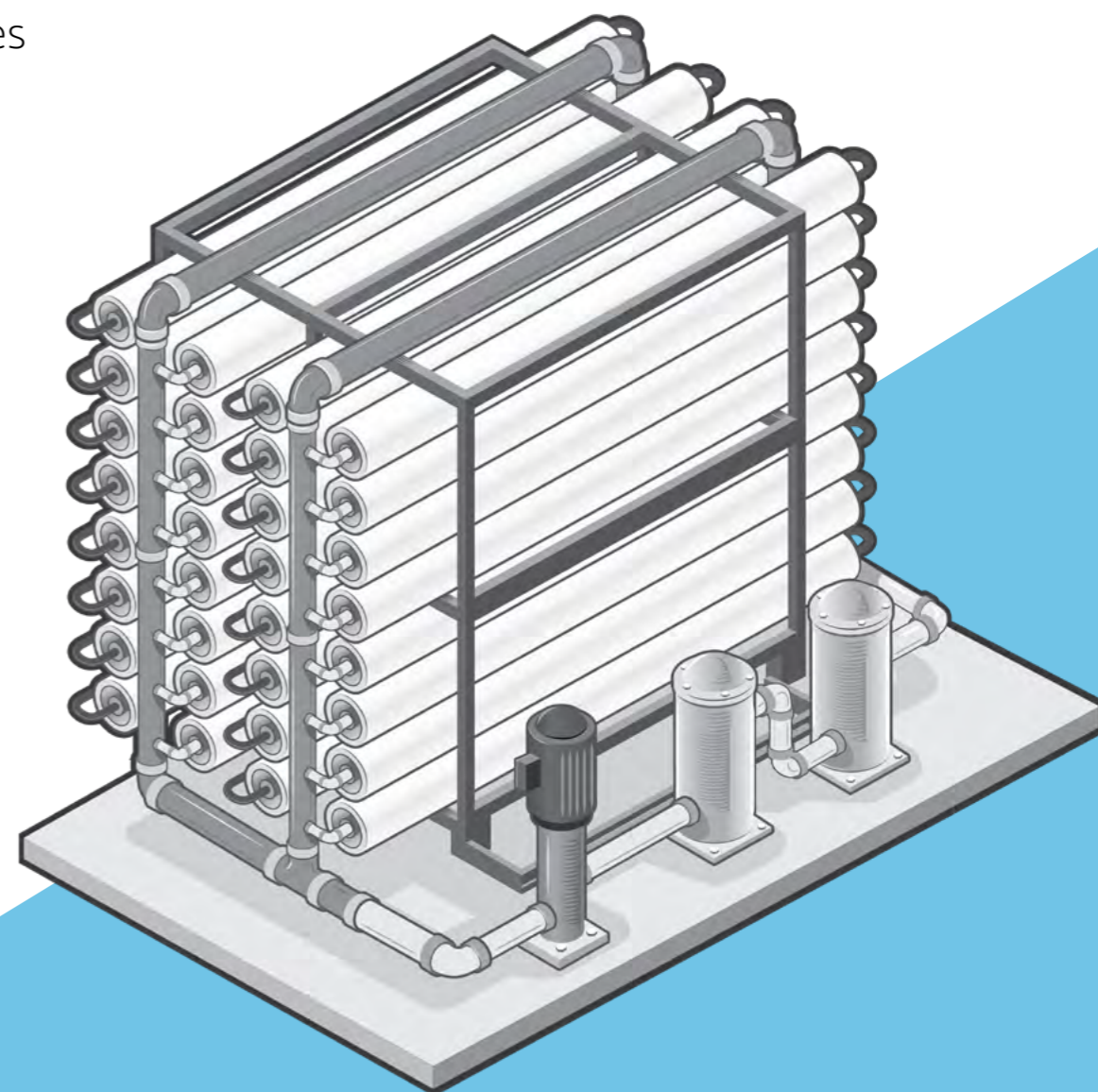
[BACK](#)[RECOMMENDED PRODUCTS](#)



COOLING TOWER BLOWDOWN

Keeping it cool.

Recover and reuse blowdown to meet compliance and minimize use of makeup water.

SEE HOW

COMMON DESIGNS

RECOMMENDED PRODUCTS

Click on technologies to better understand their role in blowdown treatment.

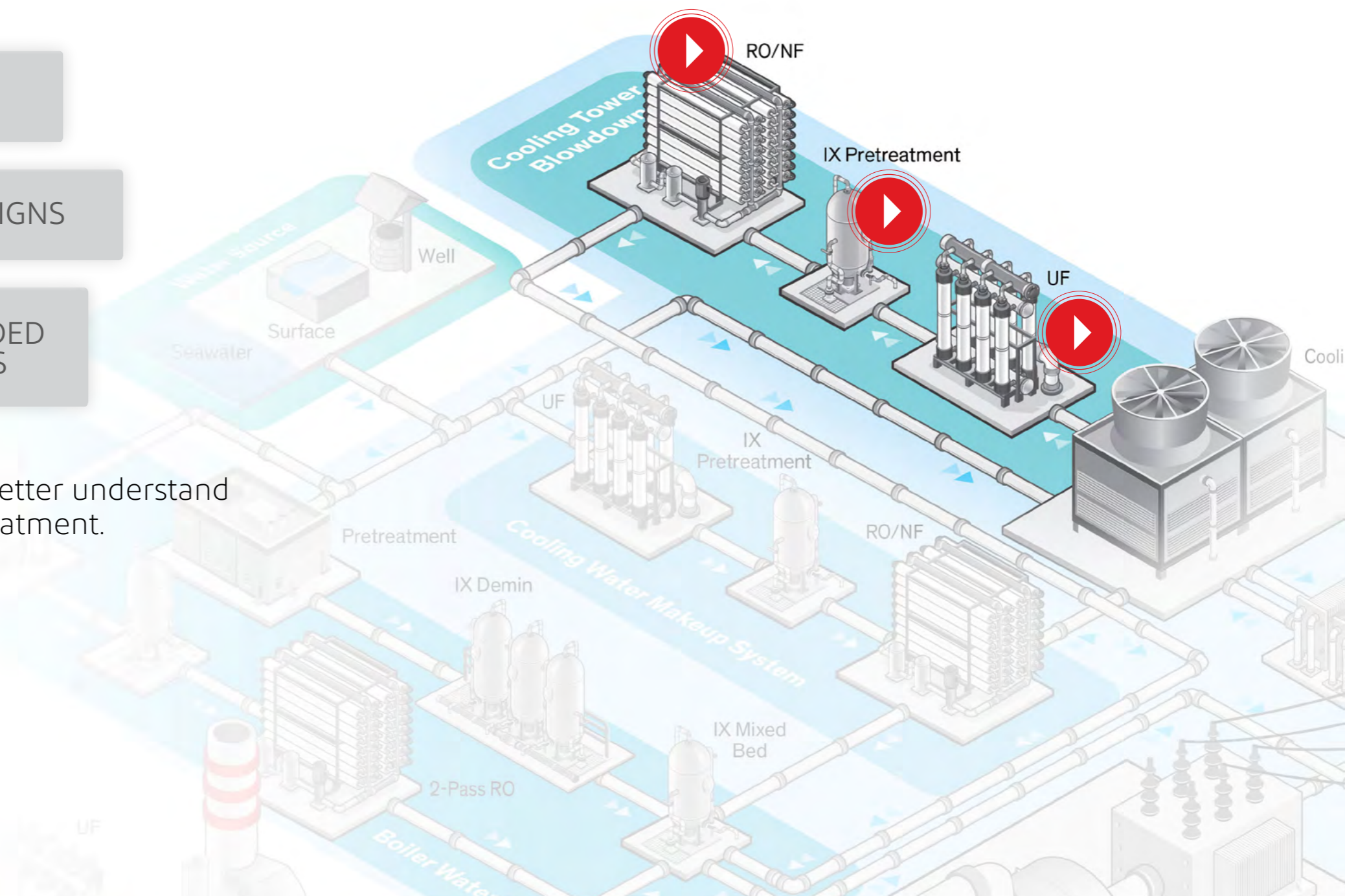



COOLING TOWER BLOWDOWN

Keeping it cool

Recov
and m

COAL FIRED POWER PLANTS • COOLING TOWER BLOWDOWN

THE CHALLENGE



Recirculating cooling water lowers a power plant's withdrawal requirements but must be blown down periodically to prevent salt buildup as water evaporates in the towers. Because the blowdown is too dirty to be reused without treatment, it is typically sent directly to the wastewater treatment plant. This imposes a hydraulic load on the wastewater treatment system. More importantly, a tremendous amount of relatively clean water is wasted, adding significant cost and compliance complexity.

THE SOLUTION



Treatment and reuse of blowdown is becoming more common throughout the world as water scarcity drives policy decisions. DuPont experts work with you to deliver the optimal solution for your needs, using robust, reliable, fouling-resistant, filtration and purification technologies to recover and return up to 90% of blowdown water for makeup.

BACK

Click o
their r

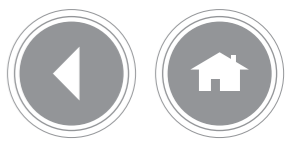

COOLING TOWER BLOWDOWN

Common Designs

Cooling tower blowdown can vary by makeup source and pretreatment but is typically high in scaling and fouling potential. Mobile systems incorporating the compact unit operations in these designs are becoming more common in some regions.

Schemes incorporating only membranes can be used when the inlet hardness and/or the desired recovery are low.

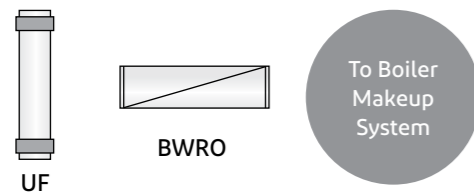

- Low TDS

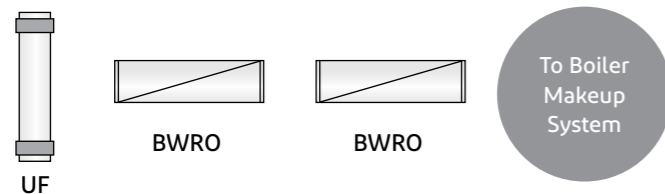

- Higher TDS

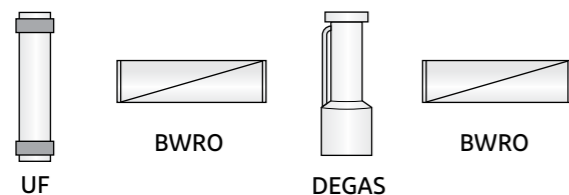

- Higher TDS and temporary hardness

[BACK](#)
[CONTACT AN EXPERT](#)

Softening pre-treatment, via precipitation, ion exchange, or even both, may be required in more challenging waters with high hardness.

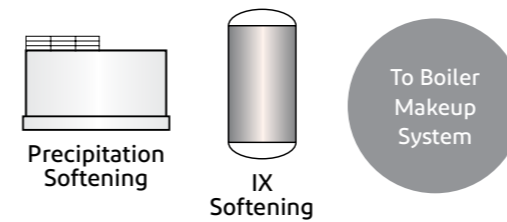

- High hardness

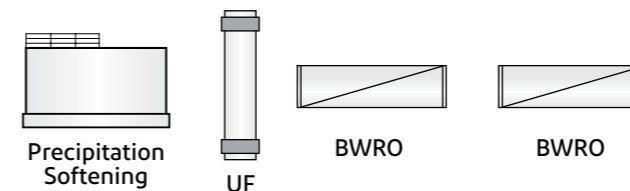

- High hardness
- Higher recovery
- Large footprint

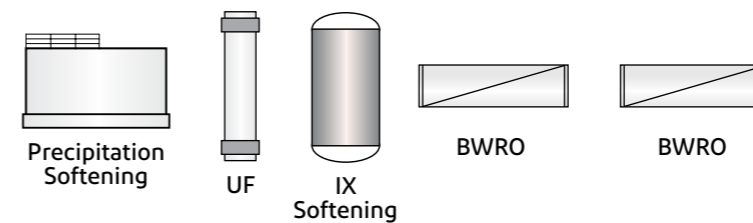

- High hardness
- Maximum recovery

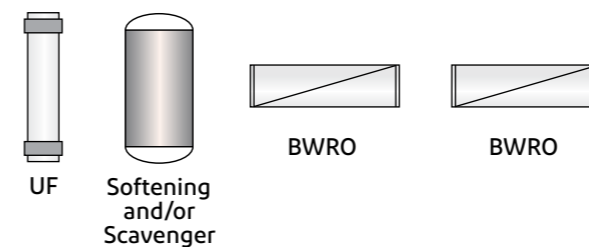

- High hardness and/or higher TDS
- Higher recovery
- Smaller footprint

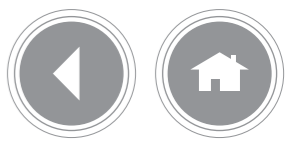

Ultrafiltration (UF)

Ultrafiltration technology removes colloids, particles and bacteria in a continuous system. It is optimally used in recycled water streams.

DuPont Unique: Provides the market's highest membrane active area, translating to smaller system footprint. All DuPont UF are made with high chemical resistance PVDF that reduces fouling and improves cleaning performance; contributing to higher system reliability and lower maintenance. Durable to withstand rigors of treating tough-to-clean cooling tower blowdown wastewater.

Benefits:

- Prevent or reduce fouling on CTBD treatment unit, ideally used as pre-treatment for operations like RO
- Reduce the impact of poor water quality on ability to recover and reuse CTBD
- Modularized, with a high level of automation and significantly smaller footprint than conventional filtration systems
- High recovery at 90-95%

The Numbers:

- Reduce RO cleaning needs by as much as 50% by using ultrafiltration as a pretreatment

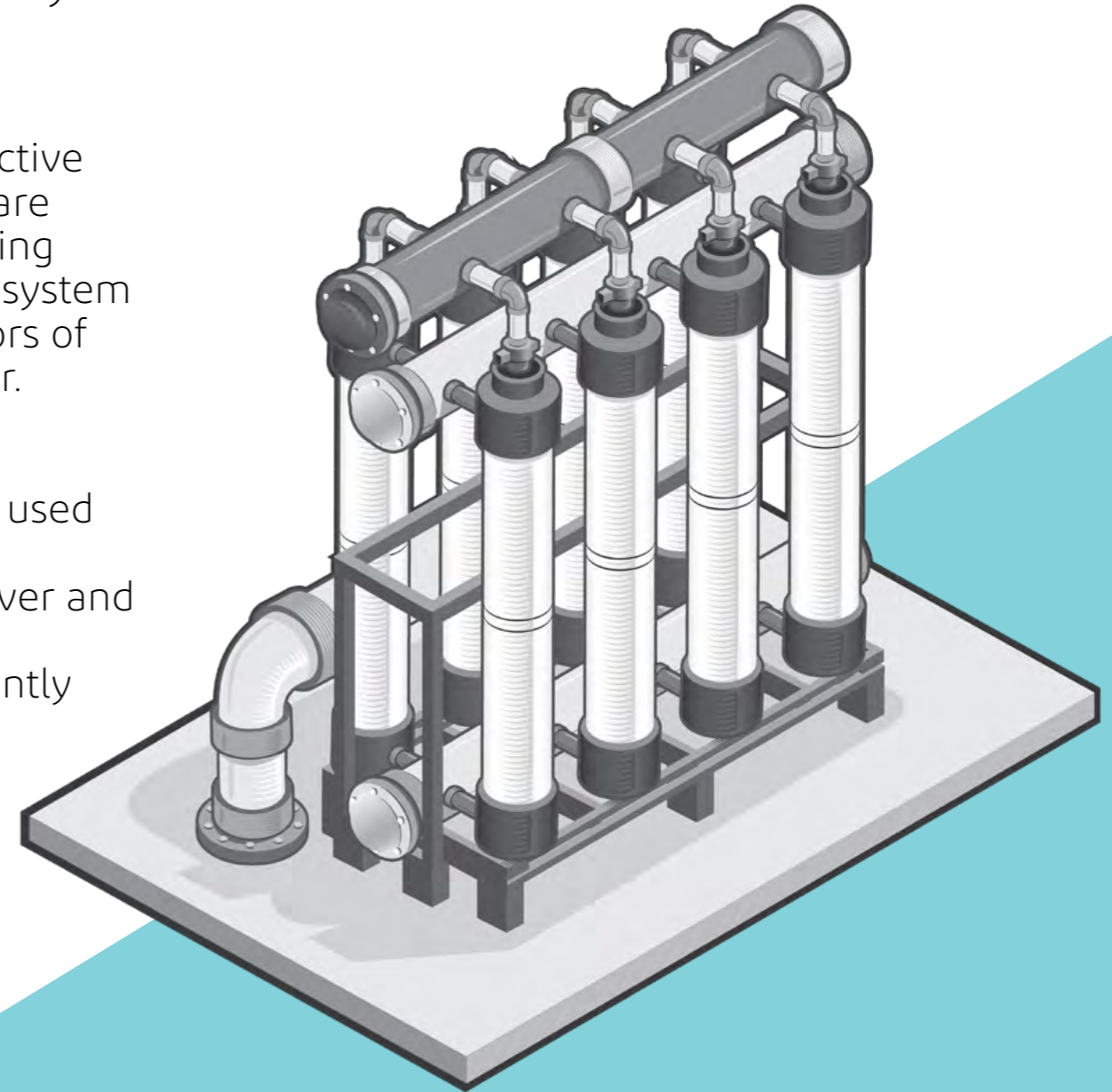
[BACK](#)[RECOMMENDED PRODUCTS](#)

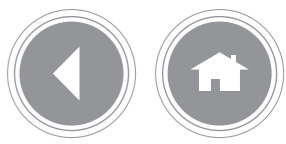

Ion Exchange (IX) Pretreatment

Purification technology that can work in high TDS/contaminant conditions to remove dissolved solids, total organic carbon, and other potential foulants.

DuPont Unique: Offers a comprehensive range of ion exchange resins, recognized for superior strength and quality, to suit your operational needs.

Benefits:

- Prevent scaling in the cooling tower circuit or downstream RO and avoid the complication and expense of using antiscalants by incorporating softening resins to remove hardness from blowdown
- Protect RO and/or UF by using strong acid cation resins to remove certain cationic polymers present from upstream coagulation systems
- Protect downstream softening and RO units with tailored strong base anion scavenging resins that remove certain organic species commonly found in CTBD wastewater

The Numbers:

- Realize up to 90% reuse of the cooling tower blowdown by adding industrial softening in front of dual membrane technology (UF + RO)

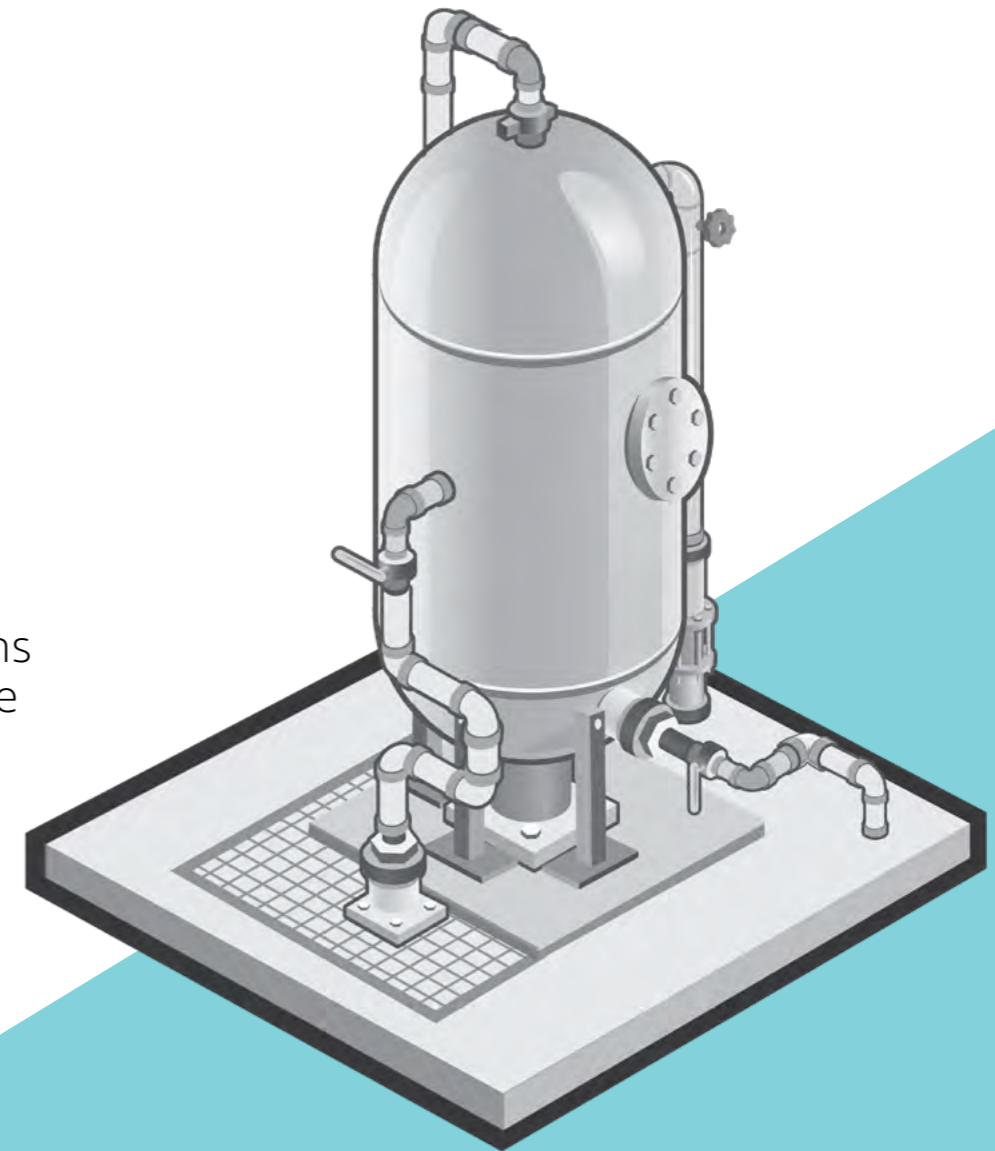
[BACK](#)[RECOMMENDED PRODUCTS](#)

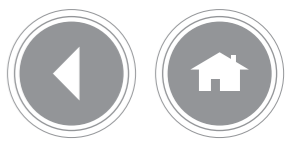

Reverse Osmosis/Nanofiltration (RO/NF)

Purification technology that can work in high TDS/contaminant conditions to remove dissolved solids, total organic carbon, and silica.

DuPont Unique: Recognized world leader in RO and NF technologies for demineralizing difficult-to-treat streams. Unique design and automated manufacturing makes them the market's most durable, fouling resistant, cleanable and reliable.

Benefits:

- Offers an ideal balance between efficient contaminant removal, demineralization, reliability and cost effectiveness
- Removes dissolved solids, silica, and total organic carbon prior to introducing water back into the cooling tower or boiler makeup system
- Tailored fouling resistant membranes handle high foulant loads from CTBD wastewater

The Numbers:

- Realize more than 70% reuse of the cooling tower blowdown when using dual membrane technology (UF + RO) together with proper pretreatment and chemical dosing

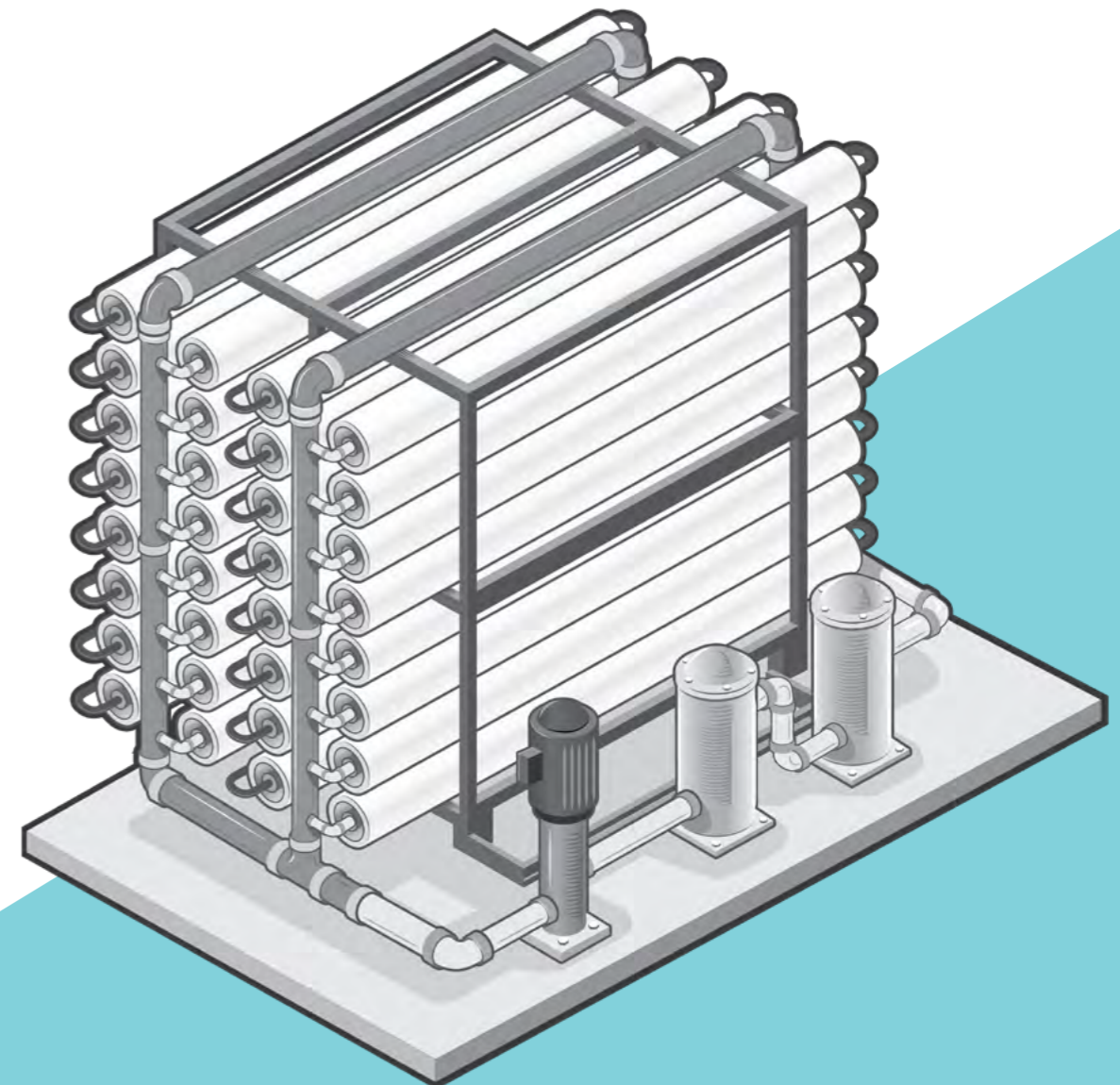
[BACK](#)[RECOMMENDED PRODUCTS](#)

CONDENSATE POLISHING

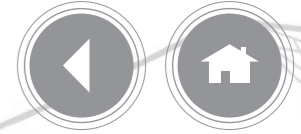

Keep your circuit clean and protected.

Remove trace contaminants and protect against condenser leaks.

SEE HOW

COMMON DESIGNS

RECOMMENDED PRODUCTS

Click on technologies to better understand their role in condensate polishing treatment.

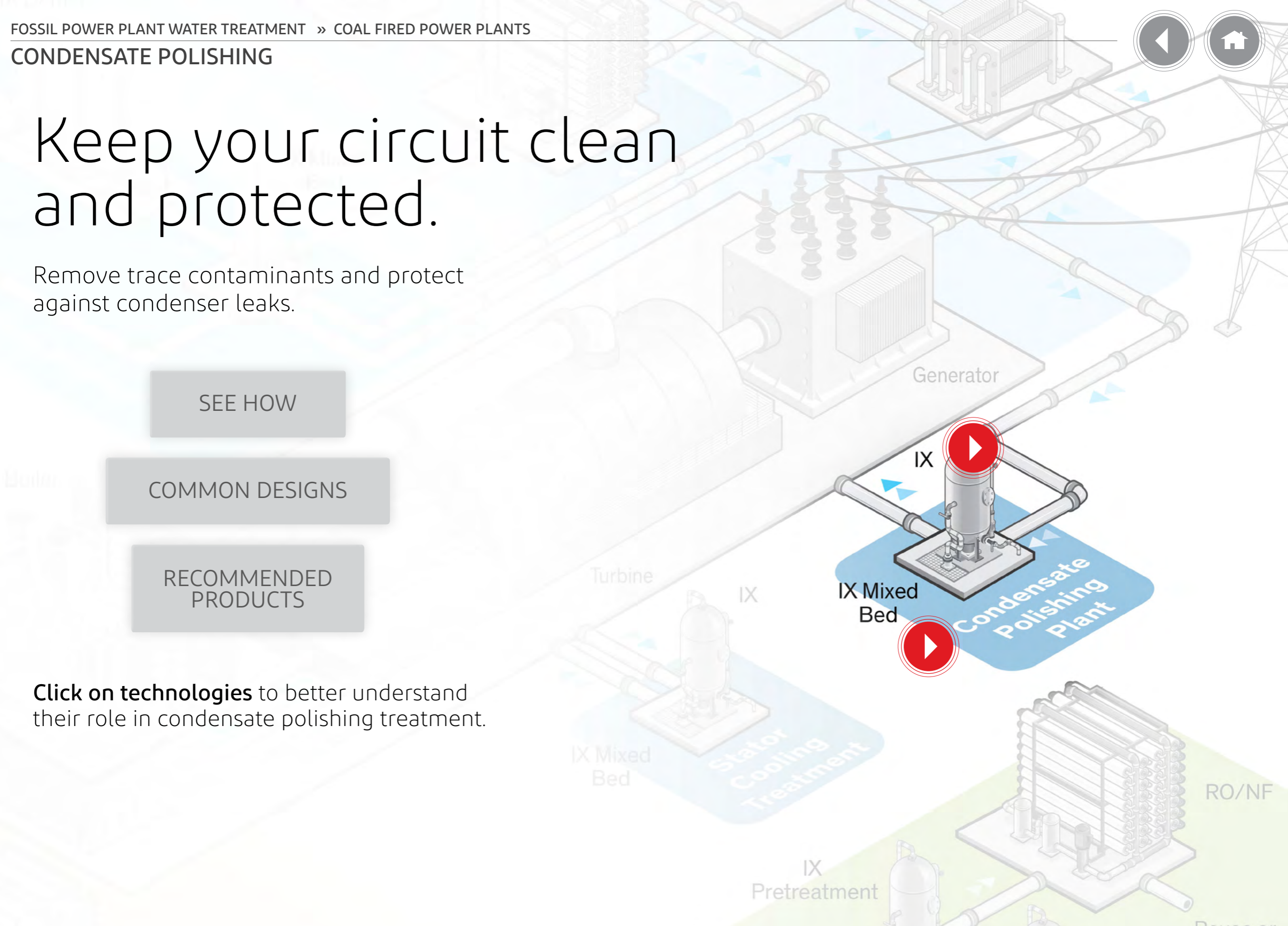



COAL FIRED POWER PLANTS • CONDENSATE POLISHING

THE CHALLENGE



The polishing plant must be optimized to the unique needs of each facility, as boiler design and amine chemistry can vary considerably from site to site. High water purity is required to prevent corrosion and protect against condenser leaks. Purity requirements, which can vary by boiler technology and steam loop chemistry, are particularly important for supercritical boilers, which create steam using once-through generators without a drum blowdown. Amines added for corrosion control are also removed by the condensate polishing plant. For plants not running their polishers past the amine break, high amine removal capacity is desired to reduce regeneration frequency and keep operating costs low.

THE SOLUTION



Ion exchange condensate polishers protect critical power plant components and improve plant reliability. Regardless of the engineering design employed, the system is only as good as the ion exchange resins used. DuPont condensate polishing resins have been protecting valuable power plant assets and improving reliability throughout the world for decades. DuPont's portfolio of resins has several offerings specifically tailored to meet the challenging demands of condensate polishing.

BACK

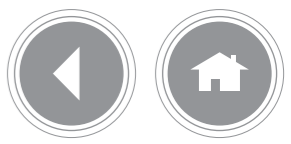

CONDENSATE POLISHING

Common Designs

A variety of schemes using ion exchange resins can be found in condensate polishing. Coal plants are sometimes run past the amine break to reduce regeneration frequency.

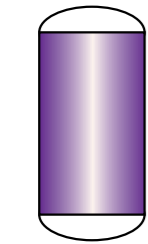

MB-H/OH

- Most common

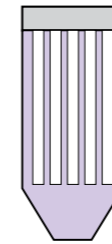
Powder
MB-(NH₄/OH
or H/OH)

- Alternative with improved filtration, common in air-cooled systems

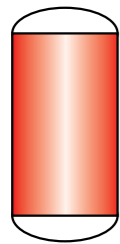

SAC-H

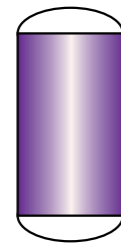

MB-H/OH

- New facilities with high amine loadings, looking to increase MB lifetime

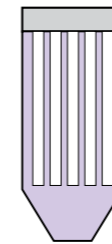
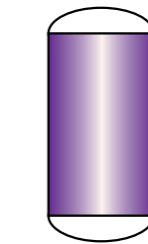
Powder
MB-(NH₄/OH
or H/OH)

MB-H/OH

- Alternative with improved filtration, high purity and long run times

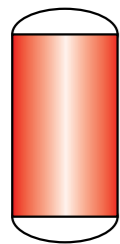

SAC-H

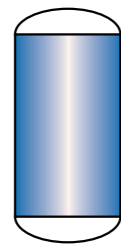

SBA-OH

- Common in air cooled systems with high temperature condensate.

[BACK](#)
[CONTACT AN EXPERT](#)

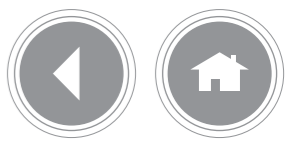

CONDENSATE POLISHING

Ion Exchange (IX)

Purification technology ideal to remove residual contaminants typically present in the low ppm to ppb range.

DuPont Unique: Recognized world-leading ion exchange brands offer superior strength and quality. DuPont offers a comprehensive range of ion exchange resins to suit the most stringent water purity requirements and operating parameters.

Benefits:

- Continue purification of the condensed steam and protect against condenser leaks
- Increase lifetime of MB condensate polishing systems by pretreatment with a strong acid cation bed to remove amines
- Great balance between performance, efficiency and life time

The Numbers:

- 20-30% longer run time and reduce corrosion during operation with high capacity gel cation resin for condensate polishing

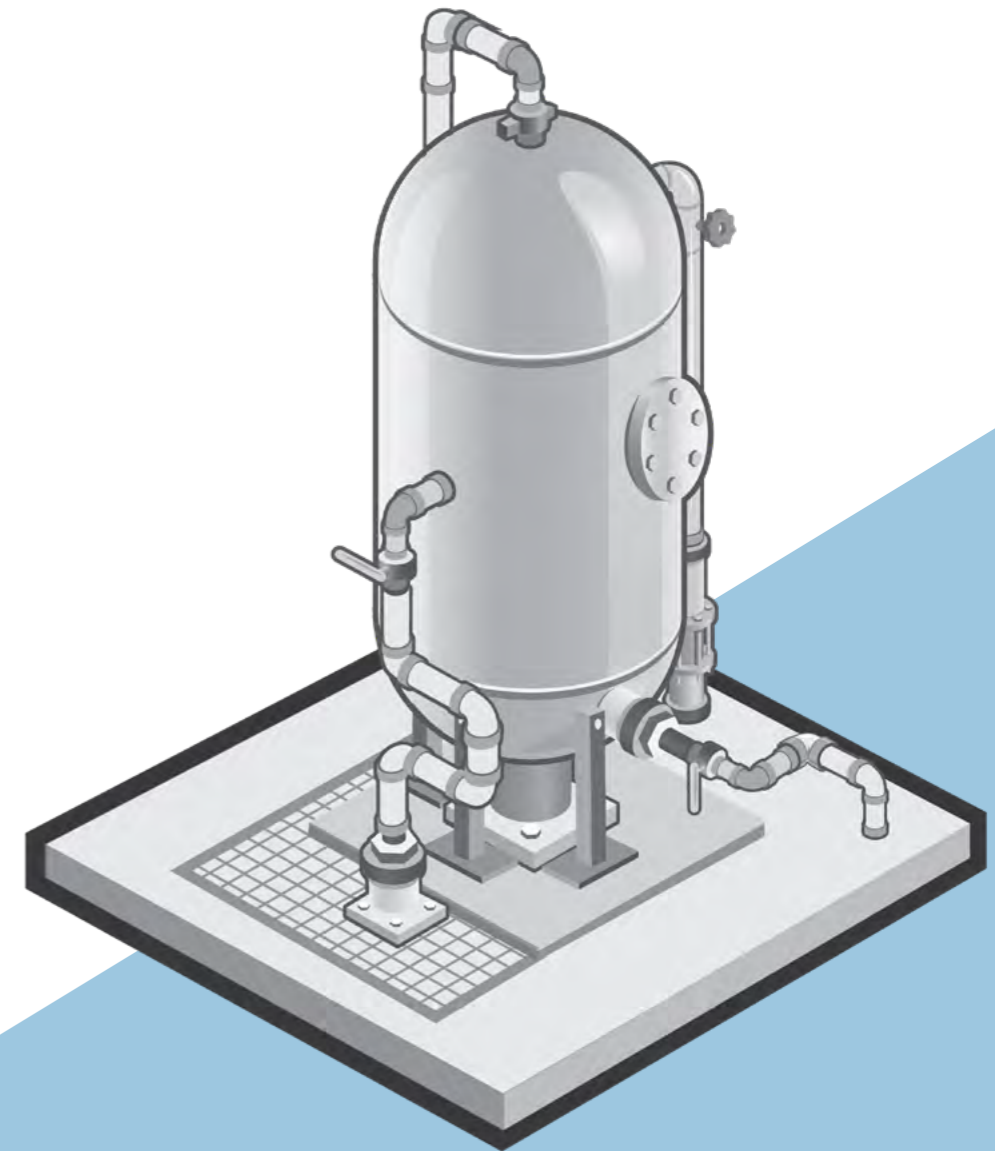
[BACK](#)[RECOMMENDED PRODUCTS](#)

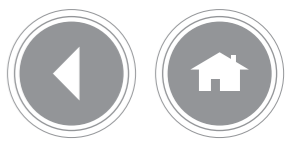

Ion Exchange Mixed Bed (IX MB)

Purification technology ideal to remove residual contaminants typically present in the low ppm to ppb range. IX MB is the standard for steam condensate treatment.

DuPont Unique: Recognized world-leading IX brands offer superior strength and quality for high performance in working and polishing MB applications.

Benefits:

- Great combination of trace contaminant removal, oxidative stability, capacity and operational life
- Premium UPS gel/gel pair is engineered for low pressure drop, outstanding separation during regeneration, and long resin life
- Macroreticular anion resins provide high anion kinetics, excellent resistance to surface fouling and high osmotic stability

The Numbers:

- 20-30% longer run time and reduced corrosion during operation with DuPont's high capacity gel cation resin
- Improve fouling resistance with a specially formulated macroporous anion resin

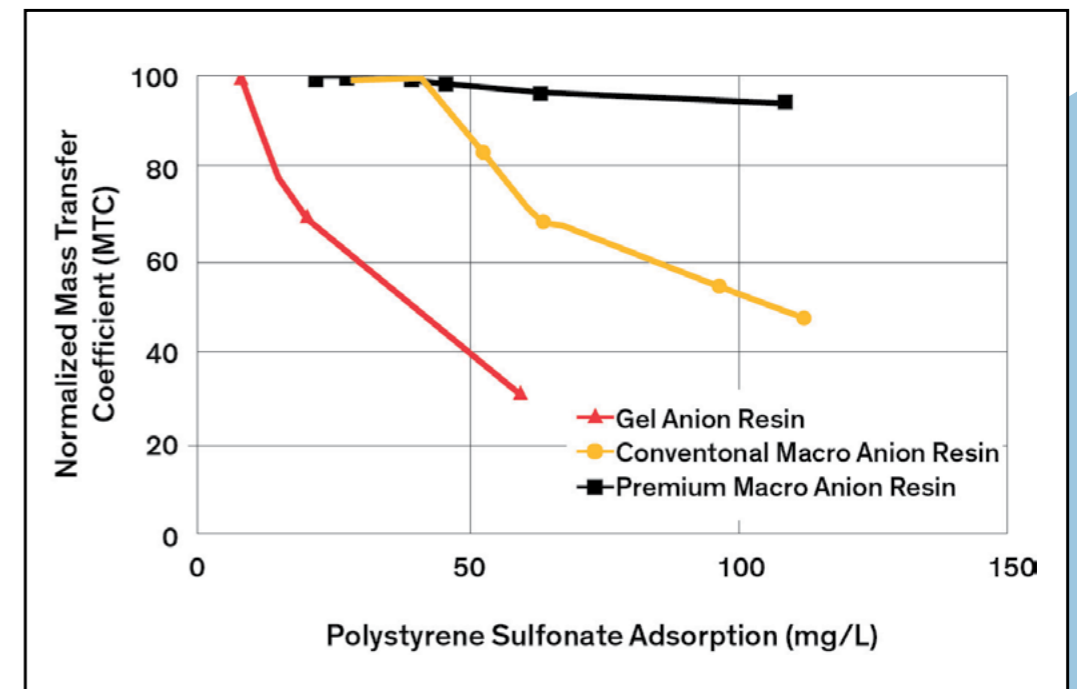

T. Ito, et al. A Quantum Leap in CPP Ion Exchange Resin Technology, 62nd International Water Conference, Pittsburgh, 2001.

BACK

RECOMMENDED
PRODUCTS

STATOR COOLING TREATMENT

A cool generator is a happy generator.

Prevent corrosion of stator bars to help prevent failure of the generator.

SEE HOW

COMMON DESIGNS

RECOMMENDED PRODUCTS

Click on **technologies** to better understand their role in stator cooling water treatment.

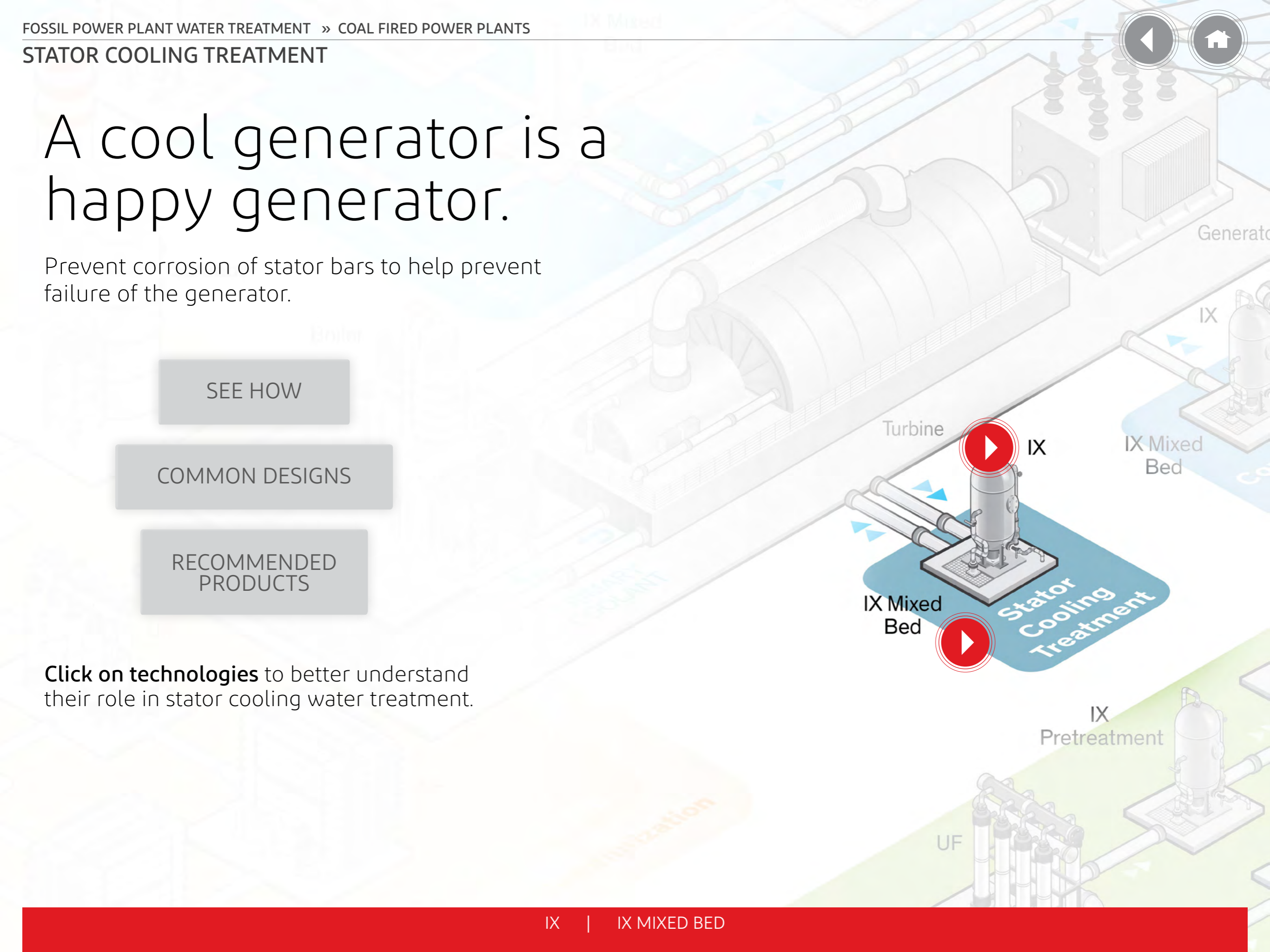



COAL FIRED POWER PLANTS • STATOR COOLING TREATMENT

THE CHALLENGE



Stator bar overheating puts an electric generator at risk of reduced efficiency or even total failure. The temperature of the bars is maintained by a closed loop cooling water circuit, which is susceptible to both corrosion and particulate fouling, for example from copper oxides. Management of copper corrosion requires highly deionized cooling water and precise management of pH and oxygen levels.

THE SOLUTION



The stator cooling system is operated in one of two regimes to minimize copper corrosion: i) elevated pH/low oxygen (<50 ppb), or ii) elevated pH/high oxygen (>2 ppm). A mixed bed polisher removes both particulates and ions introduced into the loop through makeup and corrosion. An alkaline pH can be maintained by treating a portion of the circuit with a sodium form polishing bed.

BACK

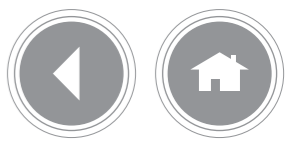

Common Designs

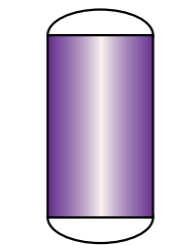

MB-H/OH

- Standard design, circuit purification

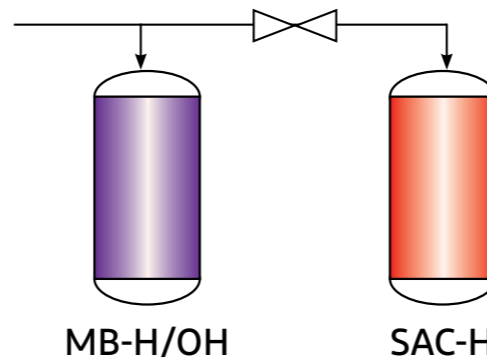

MB-H/OH

SAC-H

- Additional pH control to dissolve copper

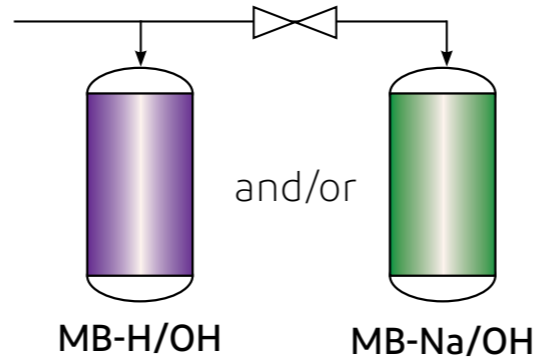

MB-H/OH

MB-Na/OH

- Circuit purification
- Na form cation resin for maintaining alkaline pH

[BACK](#)[CONTACT AN EXPERT](#)

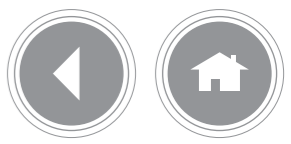

STATOR COOLING TREATMENT

Ion Exchange (IX)

Purification technology that removes residual contaminants at low levels.

DuPont Unique: Recognized world-leading ion exchange brands offer superior strength and quality for high performance applications. DuPont offers a comprehensive range of uniform particle size ion exchange resins to suit the most stringent water purity and operating parameters.

Benefits:

- Control the pH of the stator water through the optional use of a hydrogen form cation resin, allowing for the dissolution and removal of copper oxide to enhance heat transfer in the stator circuit
- Great balance between performance, efficiency and life time

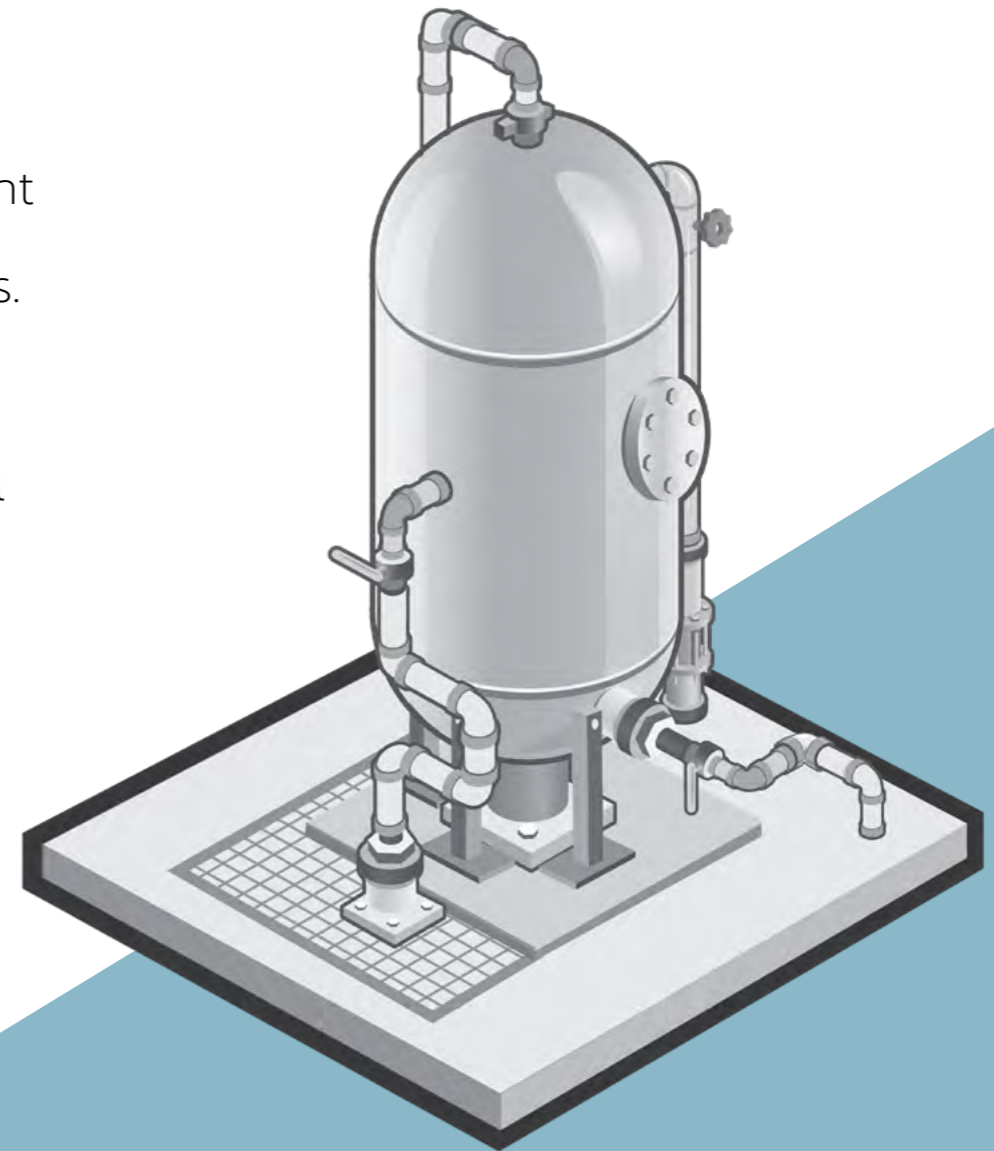
[BACK](#)[RECOMMENDED PRODUCTS](#)

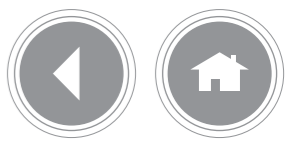

STATOR COOLING TREATMENT

Ion Exchange Mixed Bed (IX MB)

Purification technology ideal for low TDS conditions to remove residual contaminants typically present in the low ppm to ppb range.

DuPont Unique: Recognized world-leading ion exchange brands offer superior strength and quality for high performance polishing mixed-bed applications.

Benefits:

- The most effective technology used to deionize stator cooling water
- Great balance between performance, stability, efficiency and life time, with uniform particle size resins that minimize pressure drop while optimizing separation for effective regeneration
- Elevate the stator water pH to prevent copper corrosion through use of a Na/OH form MB

The Numbers:

- Triple the lifetime of this MB and reduce the risk of premature or unexpected breakthrough when using the proper configuration with a high DVB cation resin

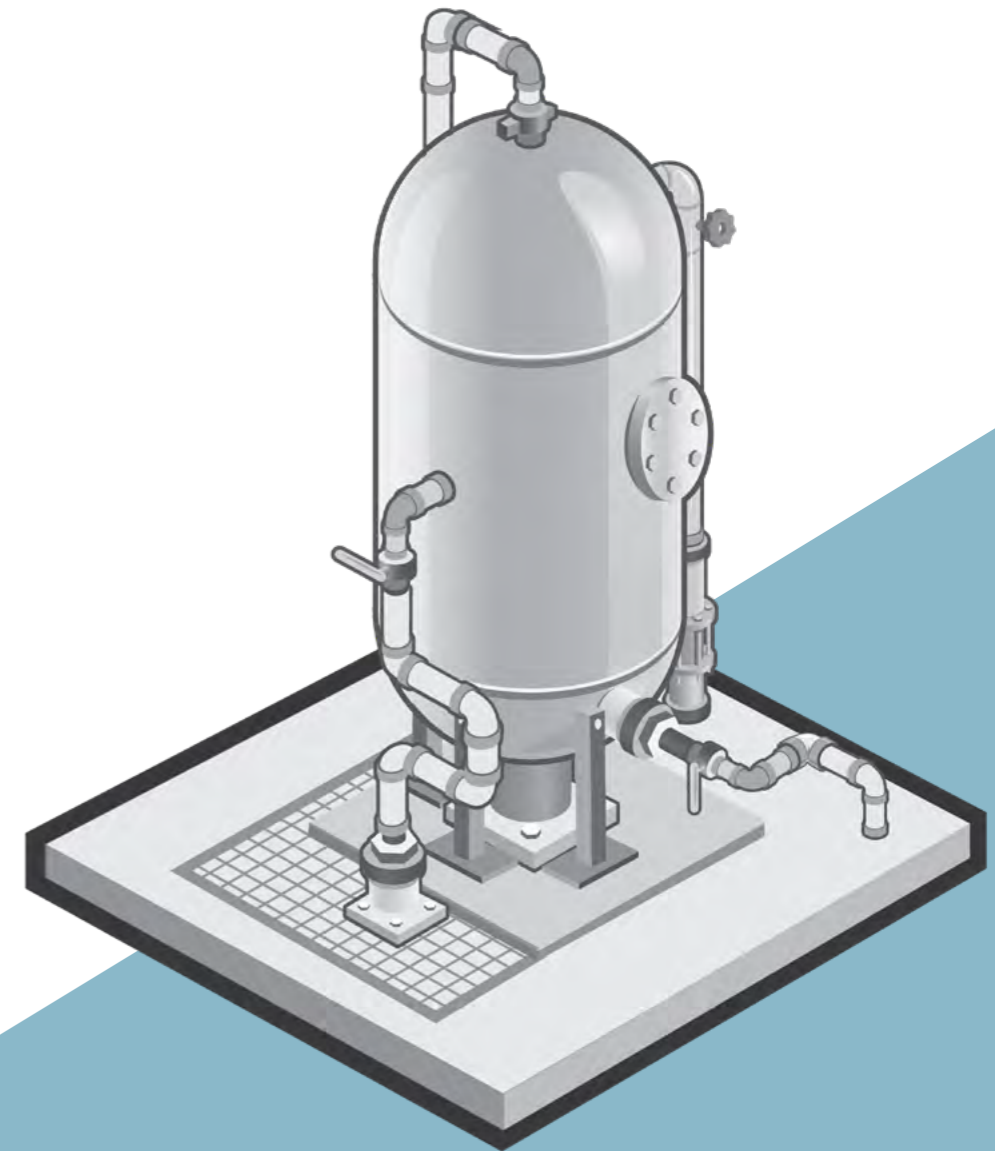
[BACK](#)[RECOMMENDED PRODUCTS](#)

FLUE GAS DESULFURIZATION

Even the most challenging waters can be treated.

Treat flue gas desulfurization (FGD) blowdown wastewater with innovative technologies to meet discharge regulations.

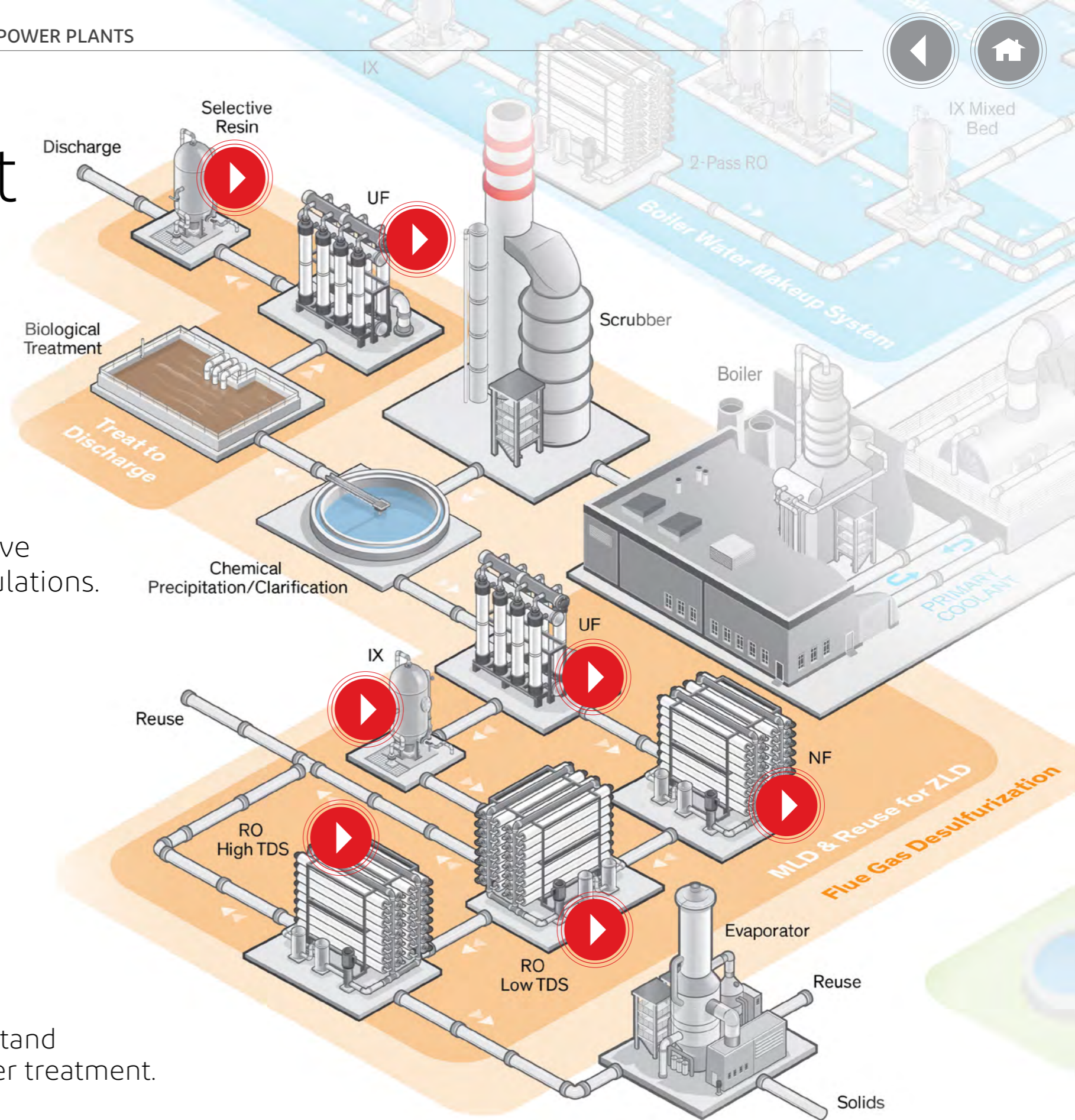

SEE HOW

COMMON DESIGNS

RECOMMENDED PRODUCTS

Click on technologies to better understand their role in FGD blowdown wastewater treatment.



COAL FIRED POWER PLANTS • FLUE GAS DESULFURIZATION

THE CHALLENGE



Wet scrubbers used to remove SO_2 and other pollutants from flue gas are periodically purged to discharge accumulated solids. This wastewater stream is high in TDS and hardness, and contains residual quantities of micropollutants (such as boron, nitrates/nitrites, arsenic, mercury and selenium) that are subject to increasingly stringent regulatory requirements. Treatments for contaminant removal or even a zero liquid discharge using evaporative technologies may be required to achieve compliance, but are challenged by both high cost and operational difficulties.

THE SOLUTION



DuPont offers a comprehensive portfolio of treatment solutions to manage the difficulties of FGD wastewater (WW). Our minimal liquid discharge solutions can be integrated into a zero liquid discharge process, trimming the high capital and operational costs required to run thermal evaporation equipment. We also offer selective media that can preferentially remove individual contaminants such as boron, mercury or other heavy metals in a treat to discharge approach.

BACK

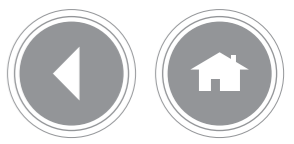

Common Designs

A multitude of strategies and designs may be considered to meet regulatory requirements for FGD WW. Two basic examples incorporating DuPont technologies are included below.

Zero Liquid Discharge

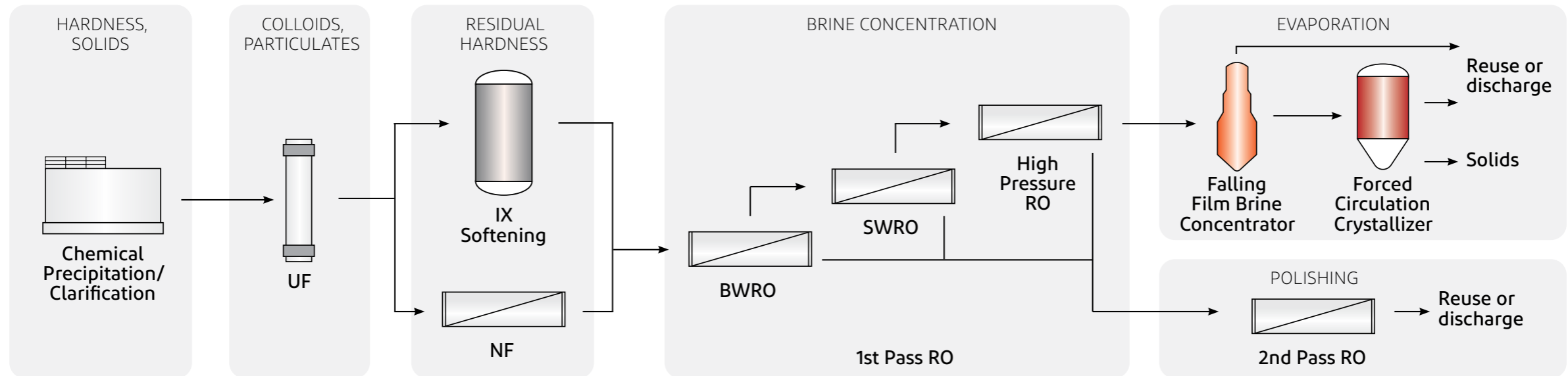

Treat to Discharge

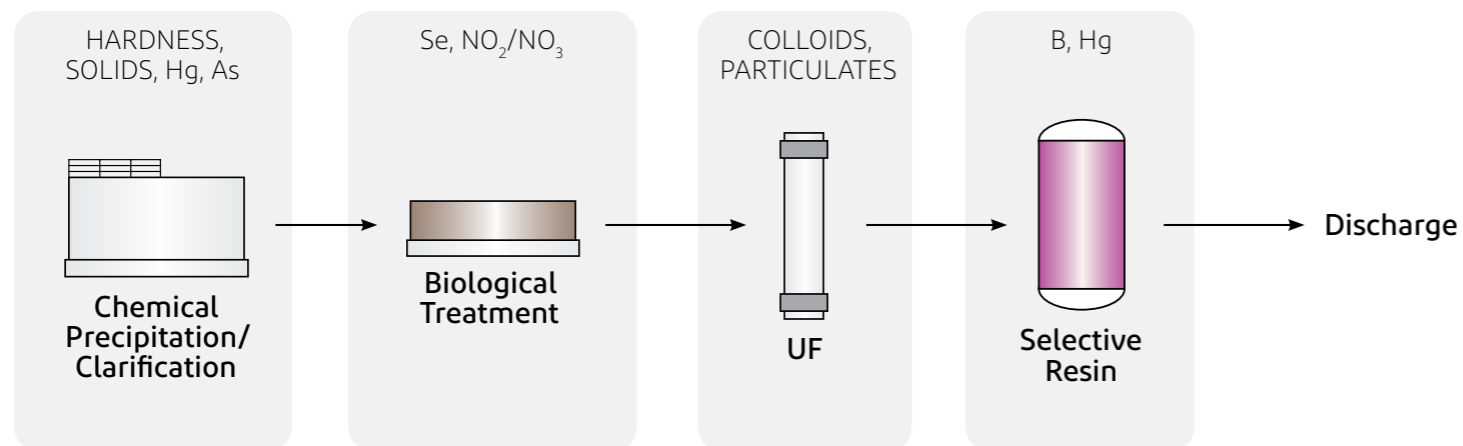

BACK

CONTACT AN EXPERT

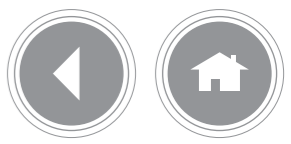

Ultrafiltration (UF)

Ultrafiltration technology removes colloids, particles and bacteria in a continuous system.

DuPont Unique: Provides the market's highest membrane active area, translating to smaller system footprint. All DuPont UF are made with high chemical resistance PVDF that reduces fouling and improves cleaning performance; providing higher system reliability and lower maintenance.

Benefits:

- Prevent or reduce fouling to enhance operability and recovery of reverse osmosis membranes used downstream to concentrate the FGD brine prior to evaporation
- Filter colloidal contaminants in a treat to discharge scenario
- Modularized, with a high level of automation and significantly smaller footprint than conventional filtration systems
- High recovery at 90-95%

The Numbers:

- Reduce RO cleaning needs by 50% by using ultrafiltration as a pretreatment
- Eliminate all colloidal such as mercury from FGD WW that would otherwise only be partially rejected by conventional filtration media

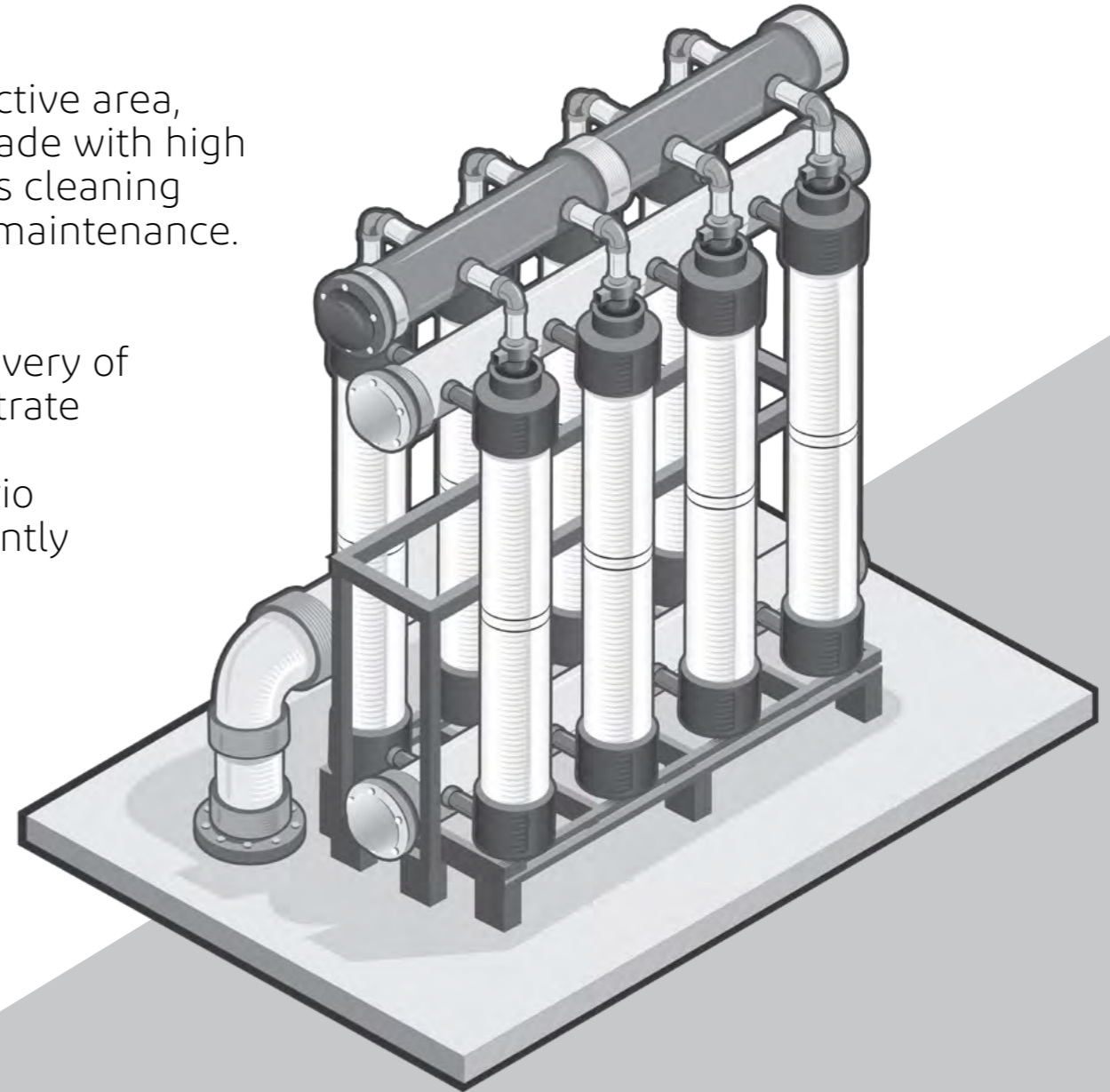
[BACK](#)[RECOMMENDED PRODUCTS](#)

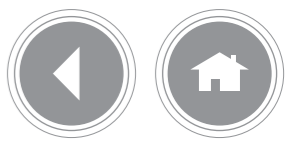

IX Softening

Purification technology that can work in high TDS/contaminant conditions to remove hardness.

DuPont Unique: Recognized world-leading ion exchange brands offer superior strength and quality. DuPont offers a comprehensive range of ion exchange resins to suit the most stringent water purity requirements and operating parameters.

Benefits:

- Prevent scaling in downstream RO by incorporating weak acid cation softening resins to remove hardness from makeup water

The Numbers:

- A properly designed weak acid cation softening resin placed after a traditional precipitation softener can lower the total hardness of FGD WW to less than 1 ppm, removing scaling barriers that would otherwise limit downstream RO recovery

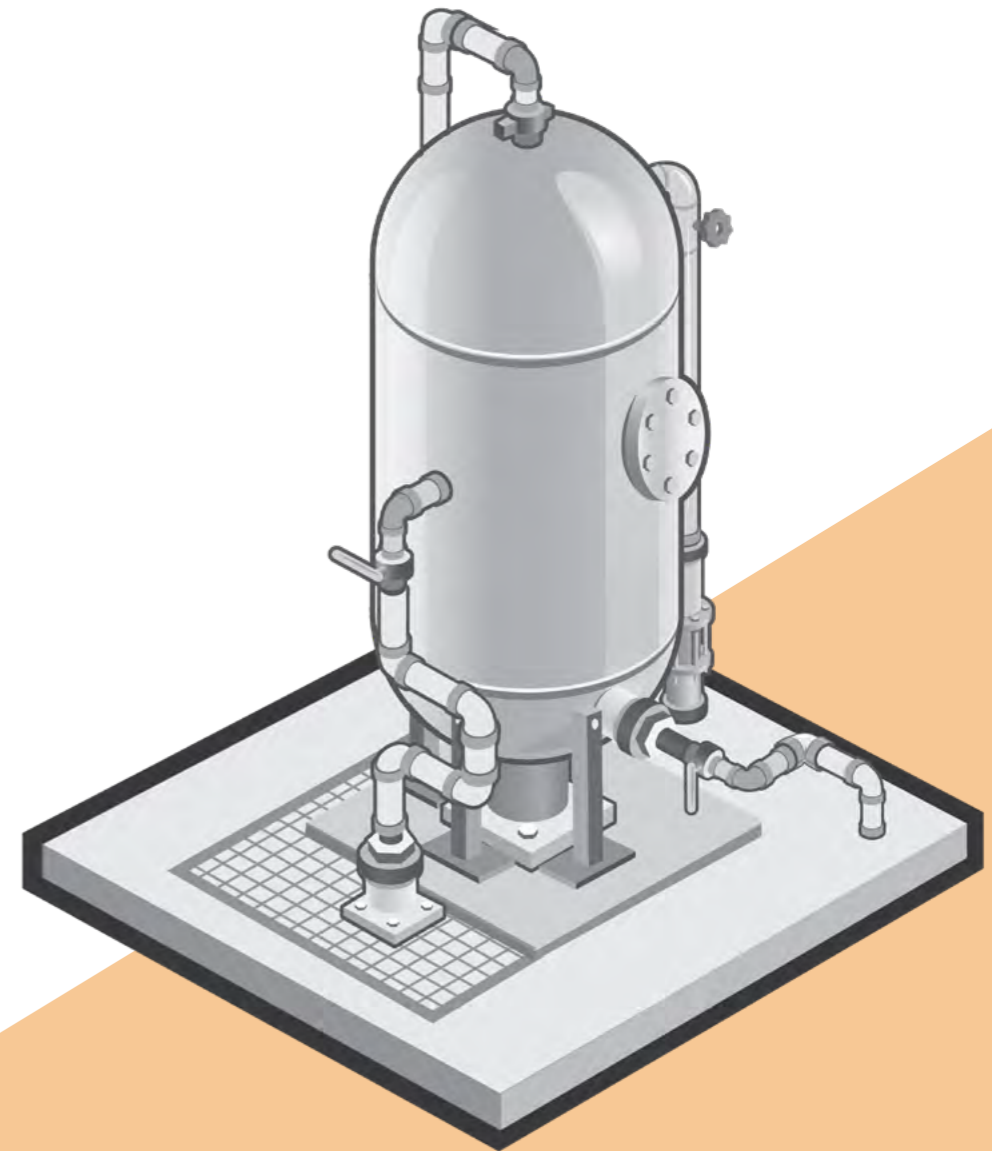
[BACK](#)[RECOMMENDED PRODUCTS](#)



Reverse Osmosis/Nanofiltration (RO/NF)

Pressure driven filtration technology that removes molecules and ions from all water types. RO is effective against all dissolved ions, while NF is selective toward rejecting ions with divalent charge.

DuPont Unique: Recognized world leader in RO and NF technologies for demineralizing difficult-to-treat streams. Unique design and automated manufacturing makes them the market's most durable, fouling resistant, cleanable and reliable.

Benefits:

- Produce permeate ideal for either internal reuse or discharge, incorporating a 2nd pass as needed to meet requirements
- Avoid scaling in downstream RO by pre-treating blowdown with selective nanofiltration membranes
- Maximize recovery with multiple RO stages, minimizing downstream thermal evaporation size and operational costs

The Numbers:

- Membranes tailored for brine concentration can process a typical FGD WW stream as high as 130,000 mg/l TDS, reducing the volume treated by downstream evaporation units by as much as 70-75%

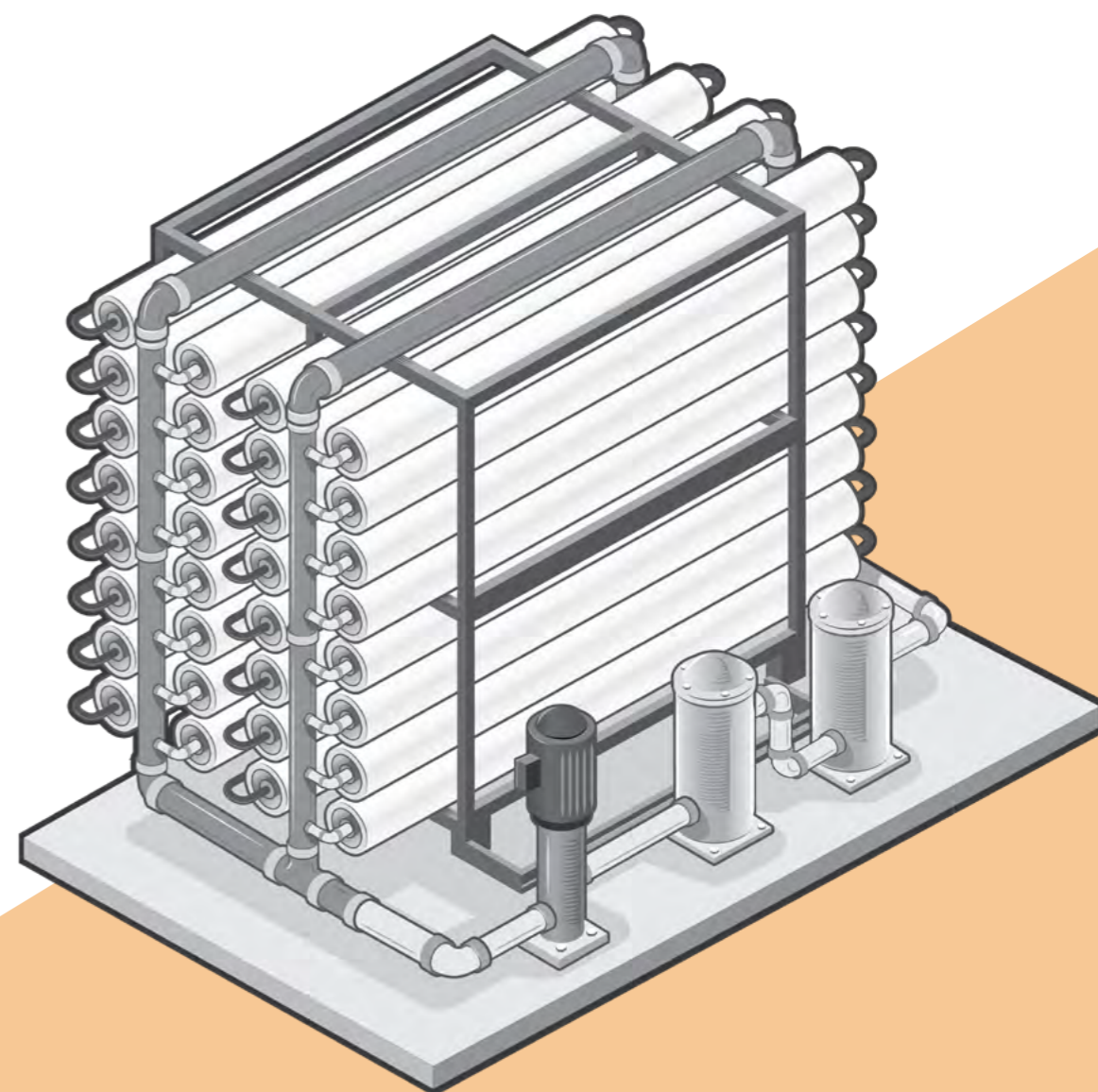
[BACK](#)[RECOMMENDED PRODUCTS](#)

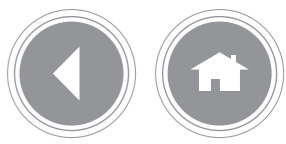

Selective Resin

Purification technology with several offerings to selectively remove micropollutants such as boron, mercury or other heavy metals like cadmium in the presence of other dissolved ions. Ideal for a treat to discharge solution.

DuPont Unique: Offers a comprehensive range of ion exchange resins with optimized selectivity, recognized for superior strength and quality, to suit your operational needs.

Benefits:

- Great combination of trace contaminant removal, selectivity, reliability, and cost effectiveness
- Selectively meet discharge requirements without the expense of removing other non-hazardous contaminants
- In certain scenarios, such as the removal of high concentrations of boron, the resin bed can be reused by regeneration. Boron is then ultimately disposed of through precipitation of concentrated regenerant solution

The Numbers:

- Reduce boron levels in FGD wastewater to as low as 5 ppm using a properly designed boron selective resin
- Reduce mercury levels in FGD wastewater to less than 5 ppt in a treatment train consisting of organosulfide chemical precipitation, sand and cartridge filtration, and ultrafiltration followed by a mercury selective ion exchange resin

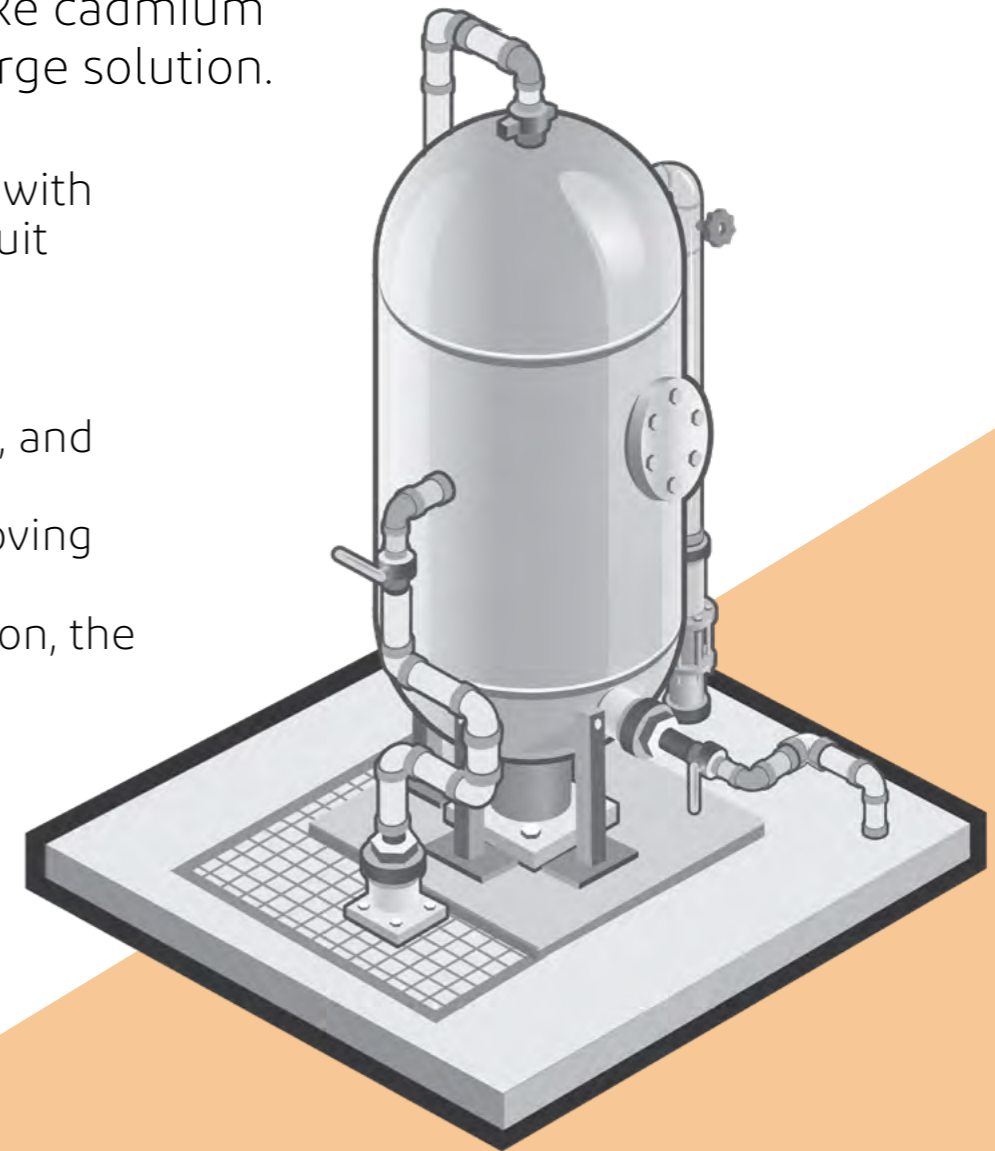
[BACK](#)[RECOMMENDED PRODUCTS](#)

ASH POND CLEANUP

Cleanup existing ponds.

Treat accumulated ash pond water with innovative technologies to meet discharge regulations.

SEE HOW

COMMON DESIGNS

RECOMMENDED PRODUCTS

Click on **technologies** to better understand their role in ash pond wastewater treatment.

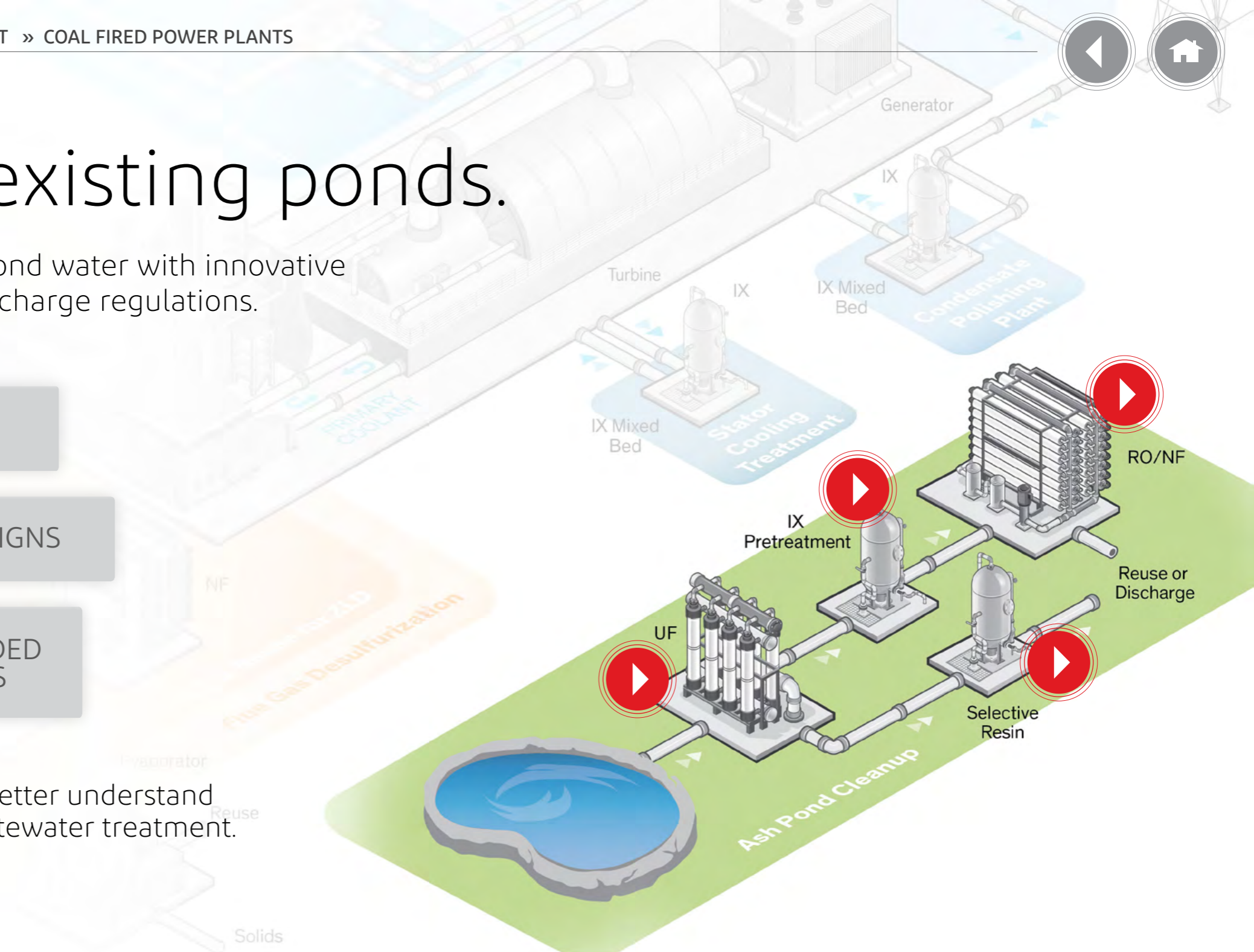



COAL FIRED POWER PLANTS • ASH POND CLEANUP

THE CHALLENGE



Ash ponds are a primary destination for many wastewater streams generated in coal-fired utilities. Chief among these streams are bottom ash and fly ash transport waters, but the ponds may also contain other wastes such as cooling tower or FGD blowdown. Ash settles in the pond and the decanted water is discharged over time. Toxic pollutants in the water are facing increasingly stringent regulations that often necessitate ash pond water be treated before discharge. Water treatment may also be required to properly close ponds which are no longer being used.

THE SOLUTION



DuPont offers a comprehensive portfolio of treatment solutions that can help manage ash pond discharge and closure. DuPont experts work with you to deliver the optimal solution for your needs, using robust, reliable, fouling-resistant, filtration and purification technologies to properly treat ash pond water for disposal or reuse.

BACK

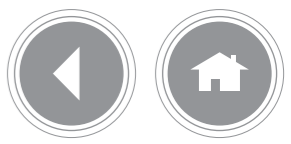

Common Designs

A multitude of strategies and designs may be considered based on regulatory requirements and the ultimate destination of the treated ash pond water. Some illustrative examples are included below.

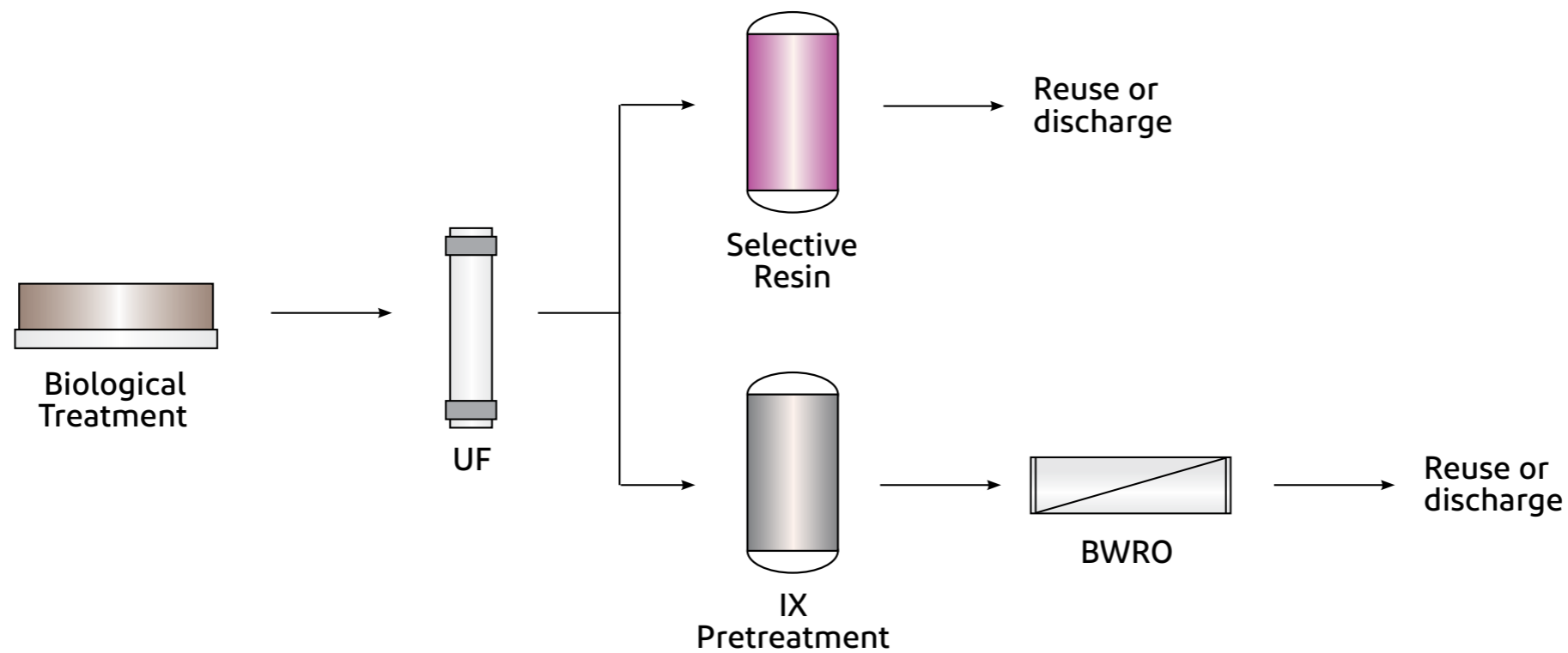
[BACK](#)[CONTACT AN EXPERT](#)

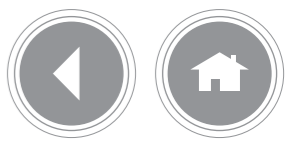

Ultrafiltration (UF)

Ultrafiltration technology removes colloids, particles and bacteria in a continuous system.

DuPont Unique: Provides the market's highest membrane active area, translating to smaller system footprint. All DuPont UF are made with high chemical resistance PVDF that reduces fouling and improves cleaning performance; providing higher system reliability and lower maintenance.

Benefits:

- Enhance operability and recovery of downstream reverse osmosis membranes by preventing or reducing fouling
- Filter colloidal contaminants in a treat to discharge scenario
- Modularized, with a high level of automation and significantly smaller footprint than conventional filtration systems
- High recovery at 90-95%

The Numbers:

- Reduce RO cleaning needs by 50% by using ultrafiltration as a pretreatment
- Eliminate colloidal material such as mercury that would otherwise only be partially rejected by conventional filtration media

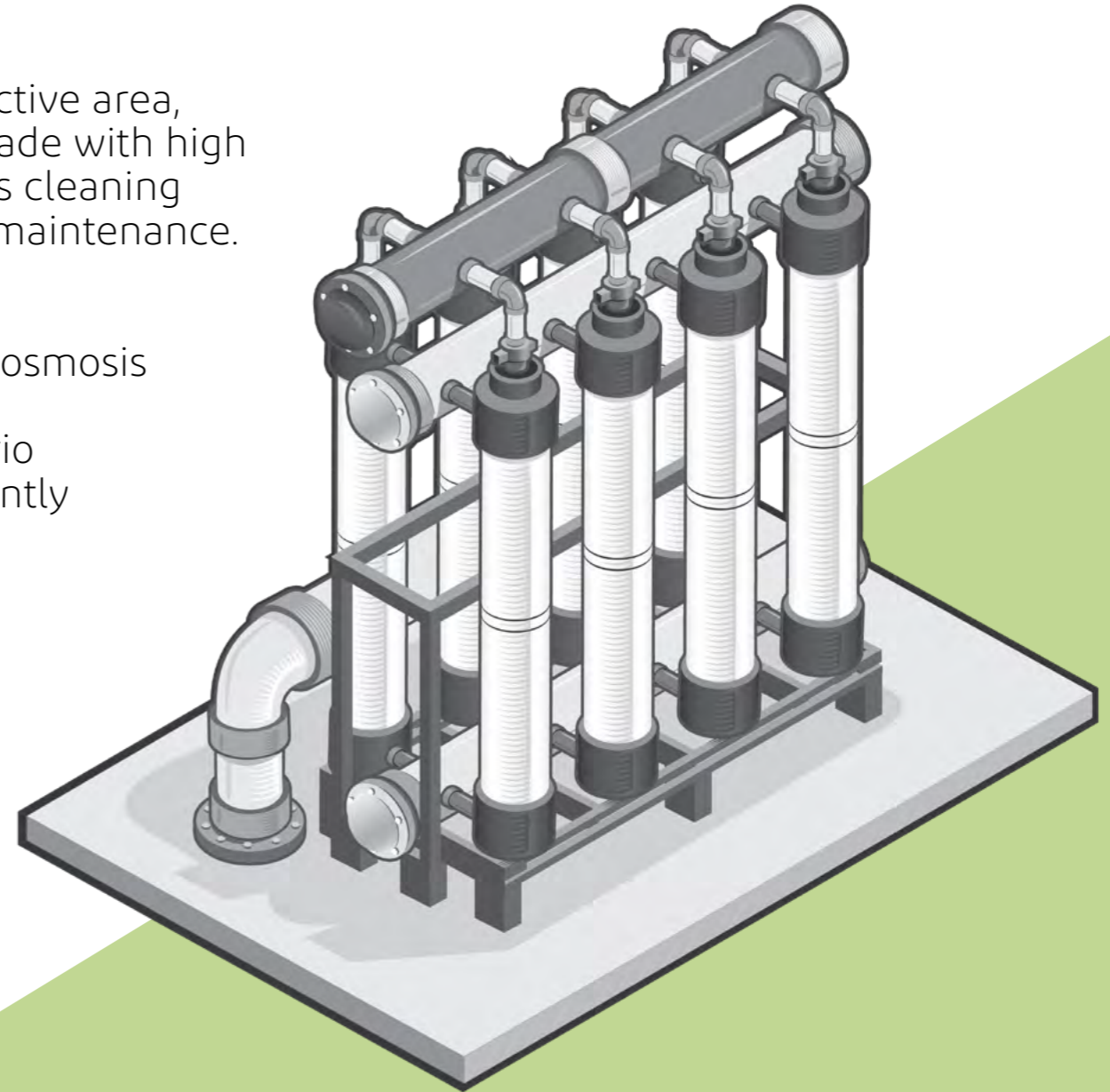
[BACK](#)[RECOMMENDED PRODUCTS](#)

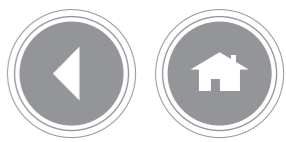

Ion Exchange (IX) Pretreatment

Purification technology that can work in high TDS/contaminant conditions to remove hardness, total organic carbon, and other potential foulants.

DuPont Unique: Recognized world-leading ion exchange brands offer superior strength and quality. DuPont offers a comprehensive range of ion exchange resins to suit the most stringent water purity requirements and operating parameters.

Benefits:

- Prevent scaling in downstream RO and avoid the complication and expense of using antiscalants by incorporating softening resins to remove hardness from makeup water
- Protect RO and/or UF by using strong acid cation resins to help remove certain cationic polymers present from upstream coagulation systems
- Protect downstream softening and RO units with tailored strong base anion scavenging resins that remove certain organic species

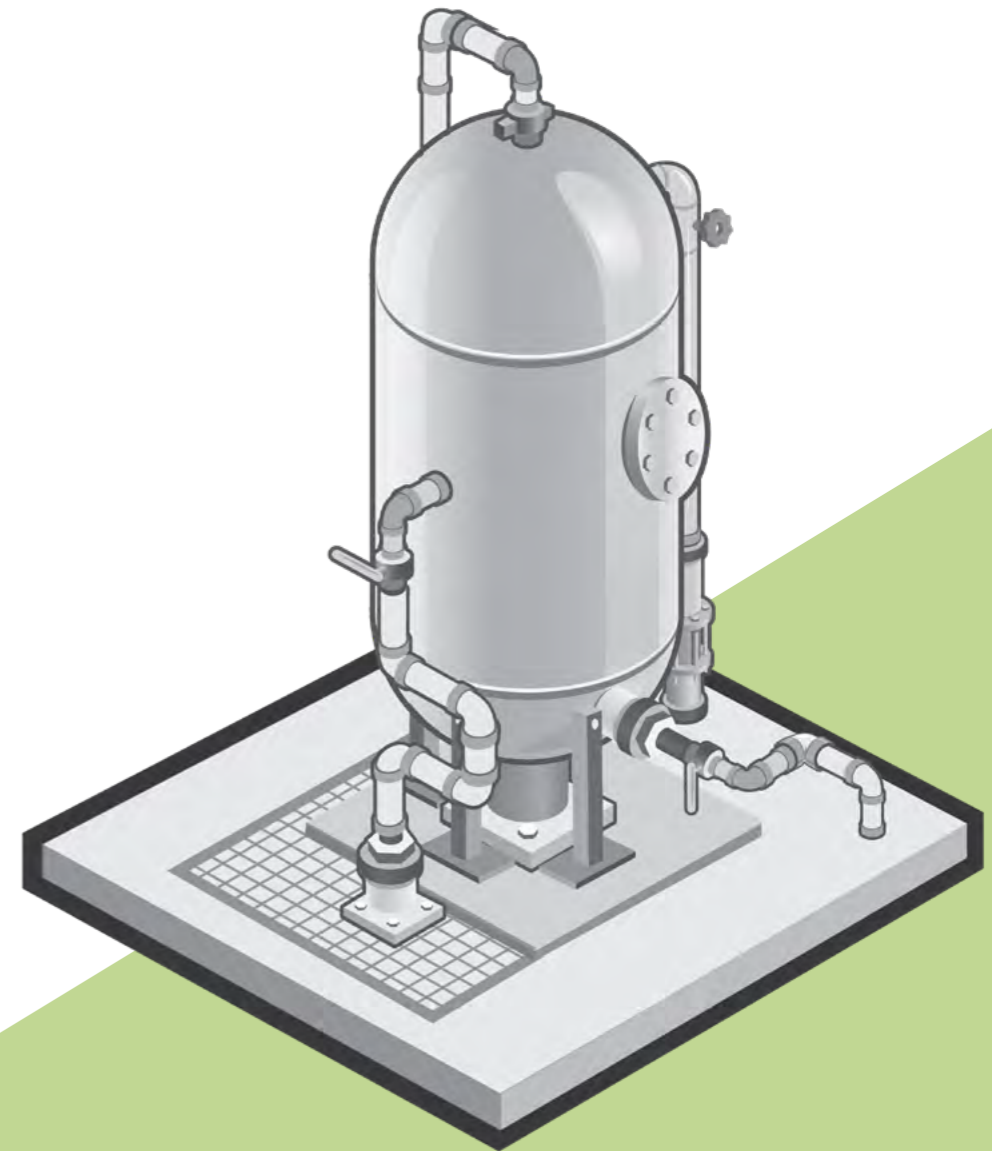
[BACK](#)[RECOMMENDED PRODUCTS](#)

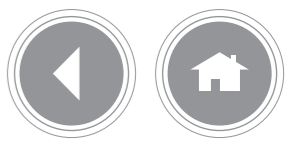

Reverse Osmosis/Nanofiltration (RO/NF)

Filtration technology that can remove many types of molecules and ions, down to specific ion level (Ca, Mg, Fe, Si, Al).

DuPont Unique: Recognized world leader in RO and NF technologies for demineralizing difficult-to-treat streams. Unique design and automated manufacturing makes them the market's most durable, fouling resistant, cleanable and reliable.

Benefits:

- Offers an ideal balance between efficient contaminant removal, demineralization, reliability and cost effectiveness
- Produce permeate ideal for either internal reuse or discharge, incorporating a 2nd pass as needed to meet requirements
- Tailored fouling resistant membranes handle high foulant loads from ash pond wastewater

The Numbers:

- Reduce frequency of RO cleanings by 20-50% by using highest fouling resistant membrane chemistries and module configurations

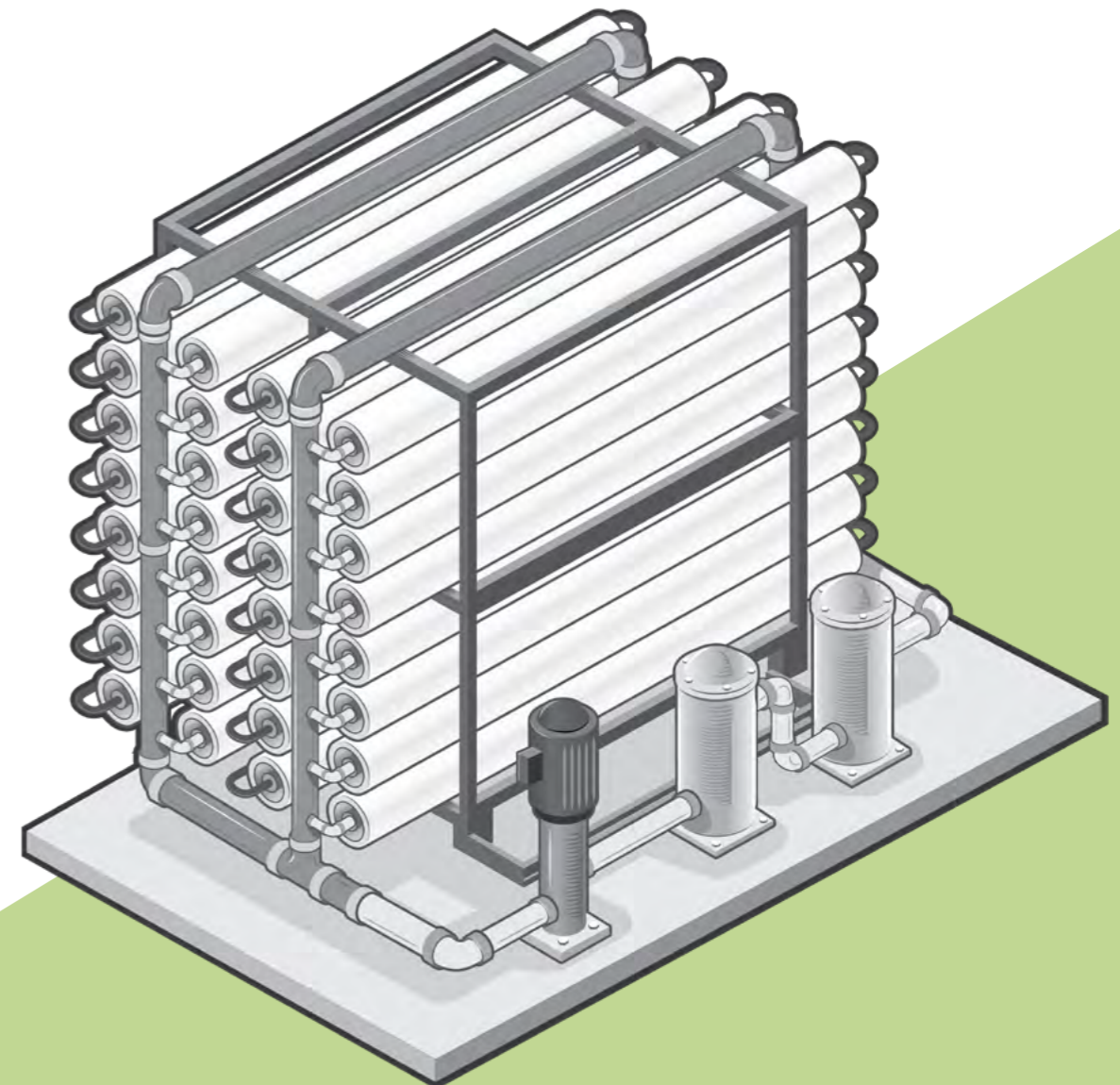
[BACK](#)[RECOMMENDED PRODUCTS](#)

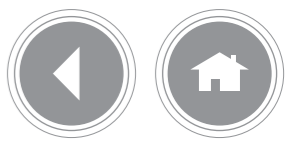

Selective Resin

Purification technology with several offerings specifically tailored to selectively remove micropollutants such as boron, mercury or other heavy metals like cadmium in the presence of other dissolved ions. Ideal for a treat to discharge solution.

DuPont Unique: Offers a comprehensive range of ion exchange resins with optimized selectivity, recognized for superior strength and quality, to suit your operational needs.

Benefits:

- Great combination of trace contaminant removal, selectivity, reliability, and cost effectiveness
- Selectively meet discharge requirements without the expense of removing other non-hazardous constituents
- In certain scenarios, such as the removal of high concentrations of boron, the resin bed can be reused by regeneration. Boron is then ultimately disposed of through precipitation of concentrated regenerant solution

The Numbers:

- Reduce boron levels in ash pond wastewater to as low as 5 ppm using a properly designed boron selective resin
- Reduce mercury levels to less than 5 ppt in a treatment train consisting of organosulfide chemical precipitation, sand and cartridge filtration, and ultrafiltration followed by a mercury selective ion exchange resin

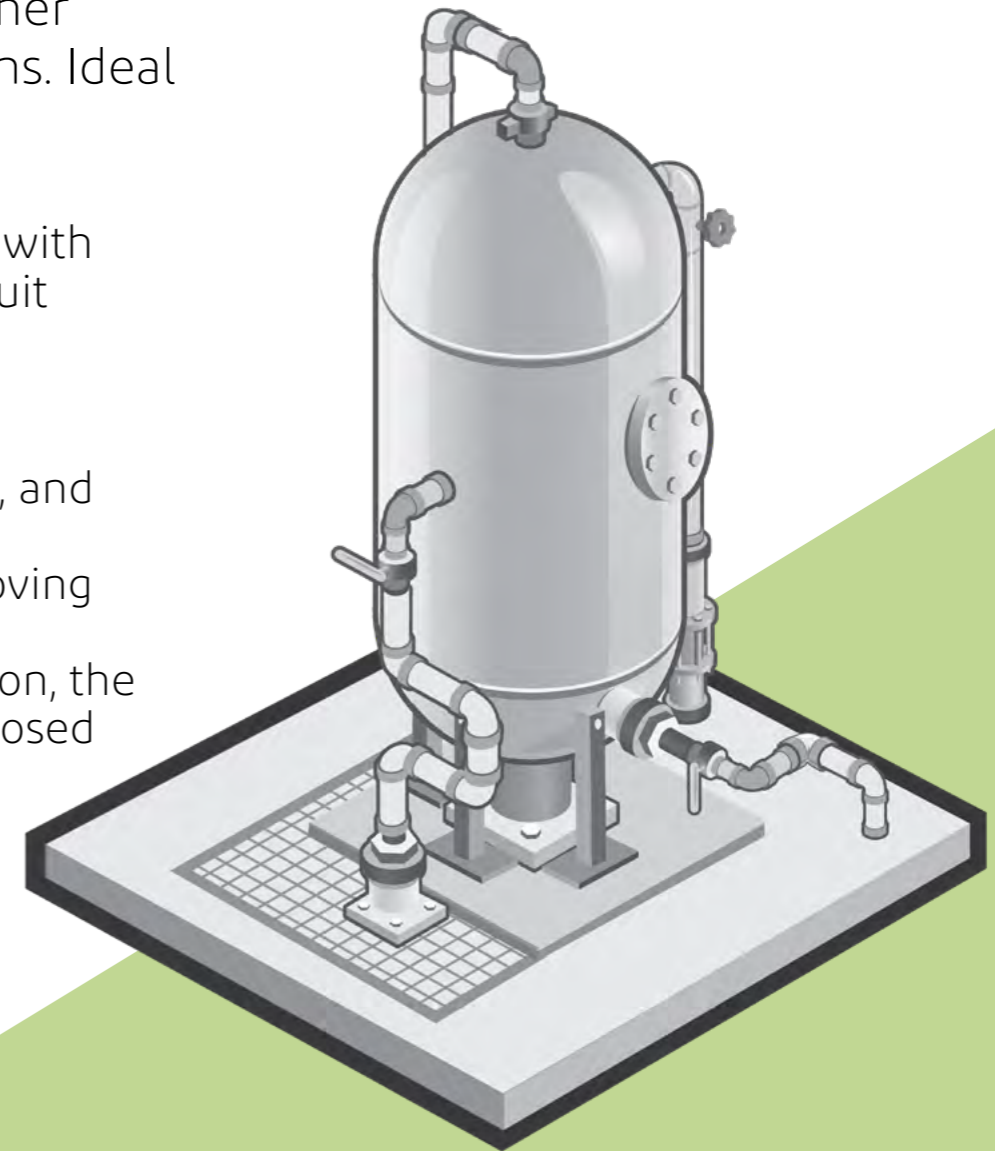
[BACK](#)[RECOMMENDED PRODUCTS](#)

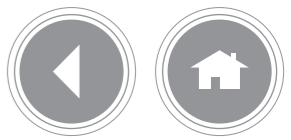

The power of water.

For decades, innovative technologies from DuPont have purified water needed to power communities worldwide.

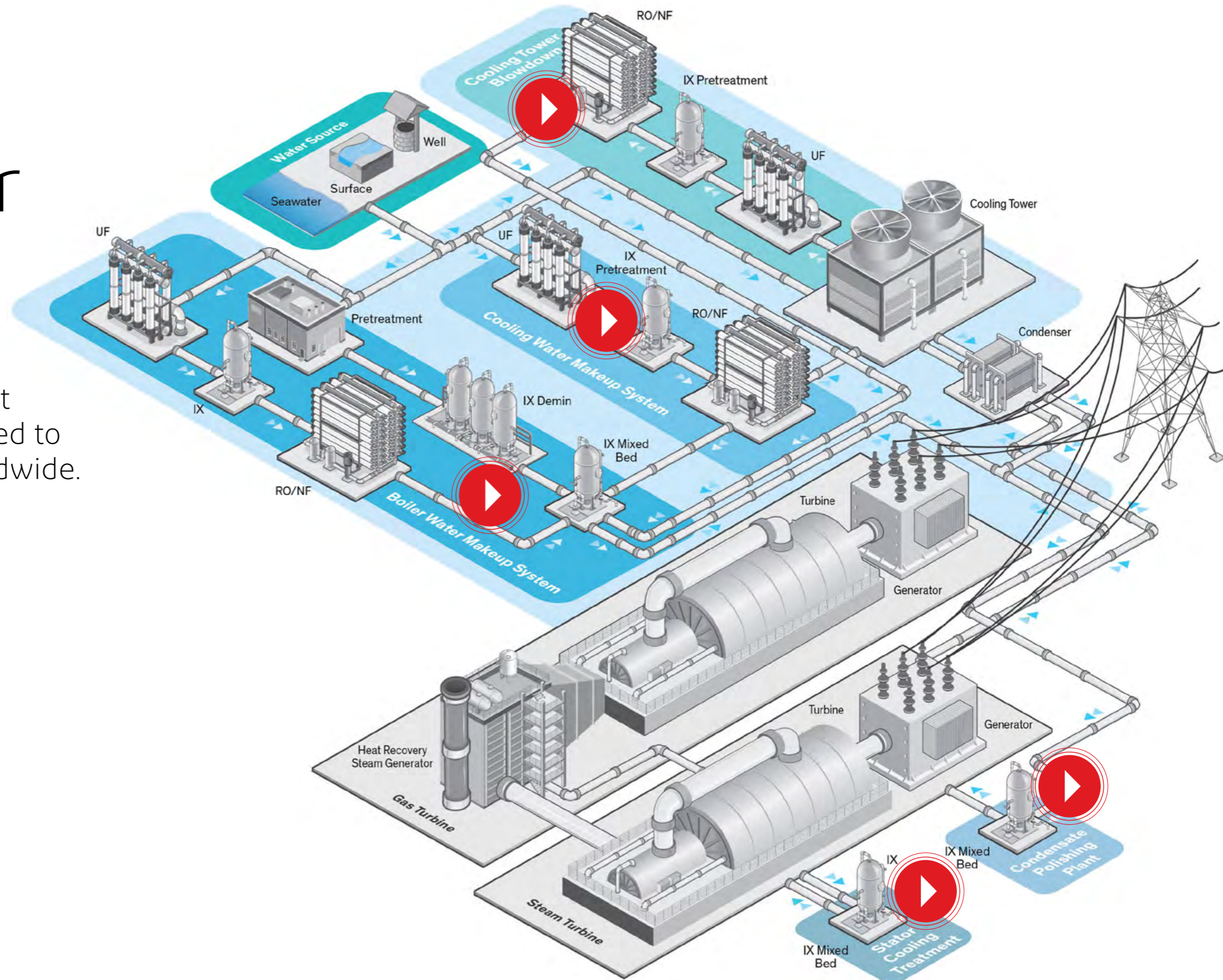

BOILER WATER MAKEUP

Boiler alert.

Reduce downtime and save money, no matter the water source or pressure requirements.

SEE HOW

COMMON DESIGNS

RECOMMENDED PRODUCTS

Click on technologies to better understand their role in makeup water treatment.

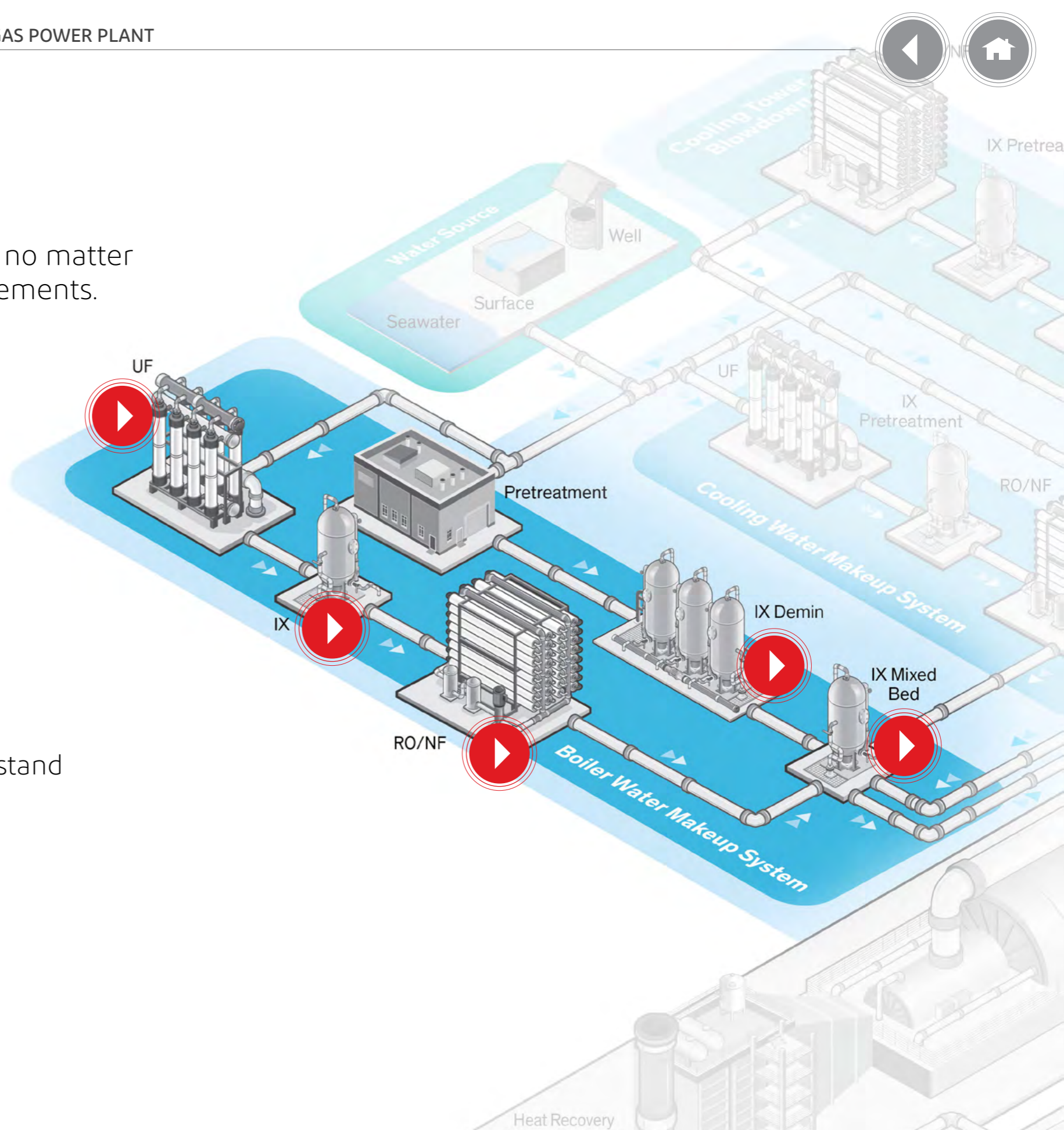



NATURAL GAS POWER PLANT • BOILER WATER MAKEUP

THE CHALLENGE



Fresh makeup water replaces losses from evaporation and blowdown in the steam/condensate loop. Varying feed conditions and boiler demands make operational efficiency difficult to maintain. Depending on the water chemistry employed and operational requirements of the boiler, contaminants must often be maintained at ppb levels to avoid scaling and corrosion. Over time, as power plant designs have been upgraded for higher efficiency, the metallurgies and processes used have placed progressively higher demands on makeup water purity.

THE SOLUTION



Treatment steps depend on the required water quality vs. the raw water quality. Regardless of which demineralization technology you prefer, DuPont has you covered. We offer comprehensive solutions for your makeup water challenges that can achieve desired quality levels, leading to optimized water use, reduced asset corrosion and boiler downtime, and ultimately trimmed operational costs.

BACK



BOILER WATER MAKEUP

Common Designs

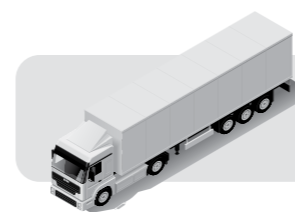

ON-SITE MOBILE DEMINERALIZER
 • May contain any of these designs

Multiple process schemes exist utilizing a combination of ultrafiltration, reverse osmosis and ion exchange technologies. Mobile systems incorporating any one of these designs are becoming more common in some regions.

Classical schemes using ion exchange minimize electrical energy and water consumption.

More commonly seen in today's fossil plants, schemes incorporating membranes reduce load on ion exchange resins, minimize chemical consumption and are more adept at handling challenging waters.

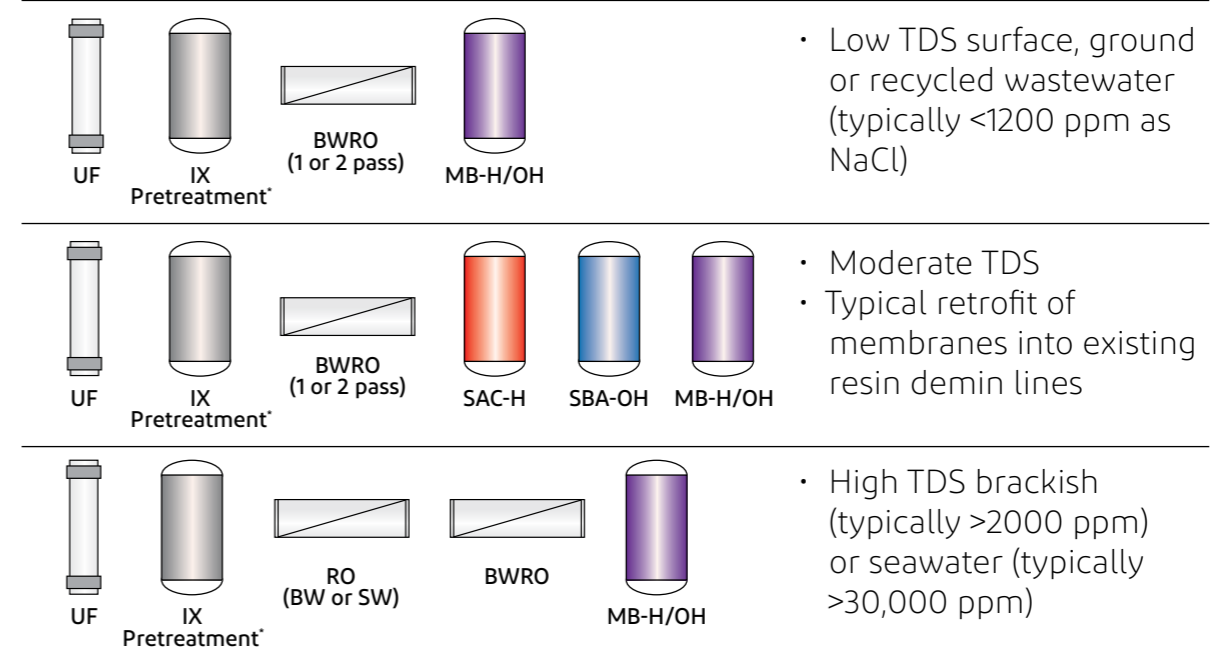
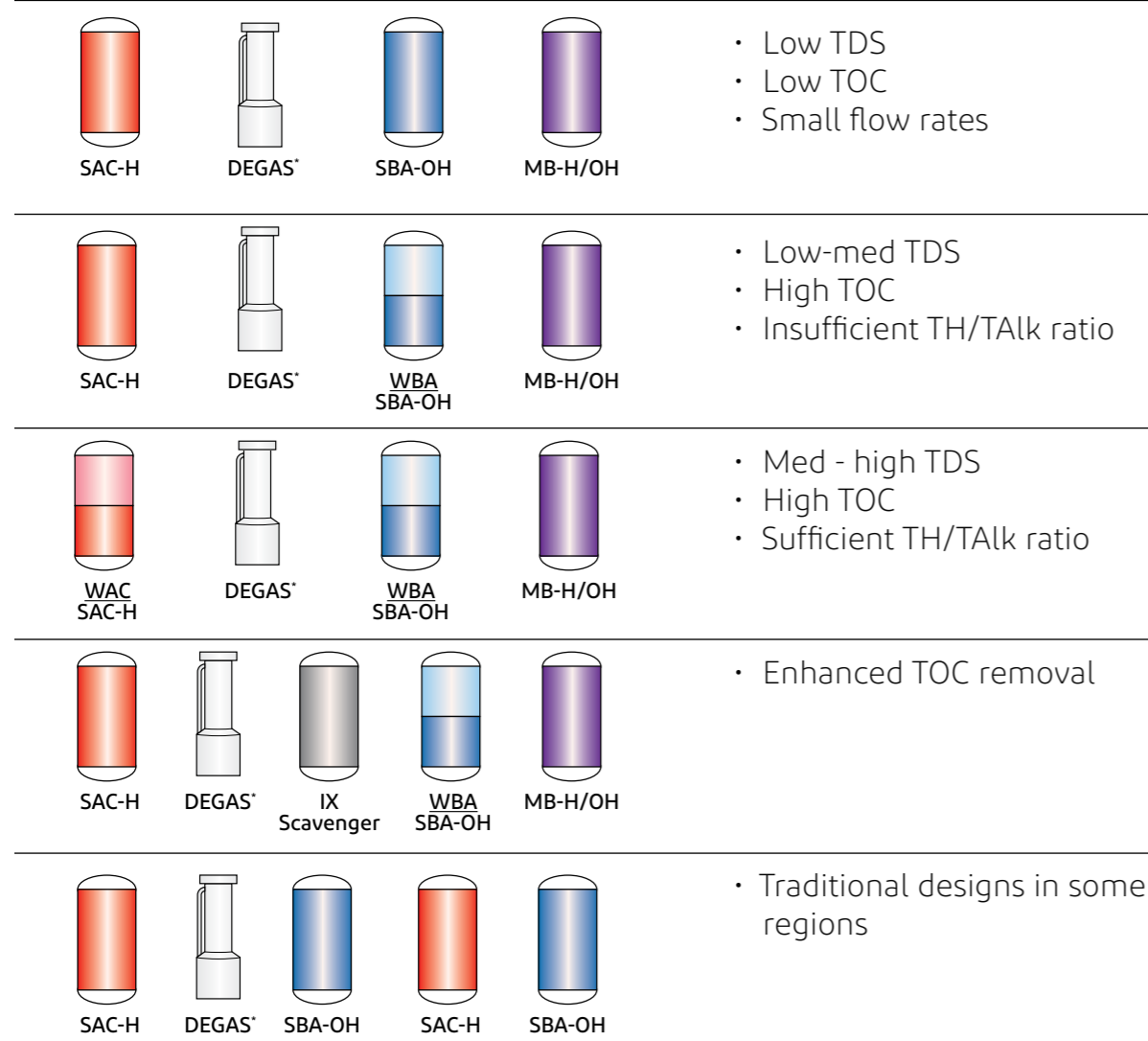

**Optional, dependency on inlet water quality*

BACK

CONTACT AN EXPERT

**In case of low alkalinity, degasifier tower may be optional*

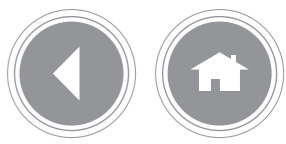

Ion Exchange Demineralization (IX Demin)

Ion Exchange removes all cations, anions, and large organic contaminants. IX demineralization consists of at least two resin beds: a hydrogen form strong acid cation resin followed by a hydroxide form strong base anion resin. A degasifier may be used between them to remove alkalinity. Weak acid cation and/or weak base anion may also be incorporated, depending on levels of TDS, hardness, TOC and alkalinity.

DuPont Unique: The widest range of industry-leading, reliable ion exchange resins from world-class manufacturing facilities.

Benefits:

- Reduce key ionic contaminants down to the microgram per liter concentrations required for steam generation in fossil-fired power plants

The Numbers:

- Save up to 40% in OPEX and receive up to 10x better water quality by using reverse flow beds over conventional co-flow systems
- Further lower cost by 25% using AMBERPACK™ and UPCORE™ packed beds, which use less regenerant and service water

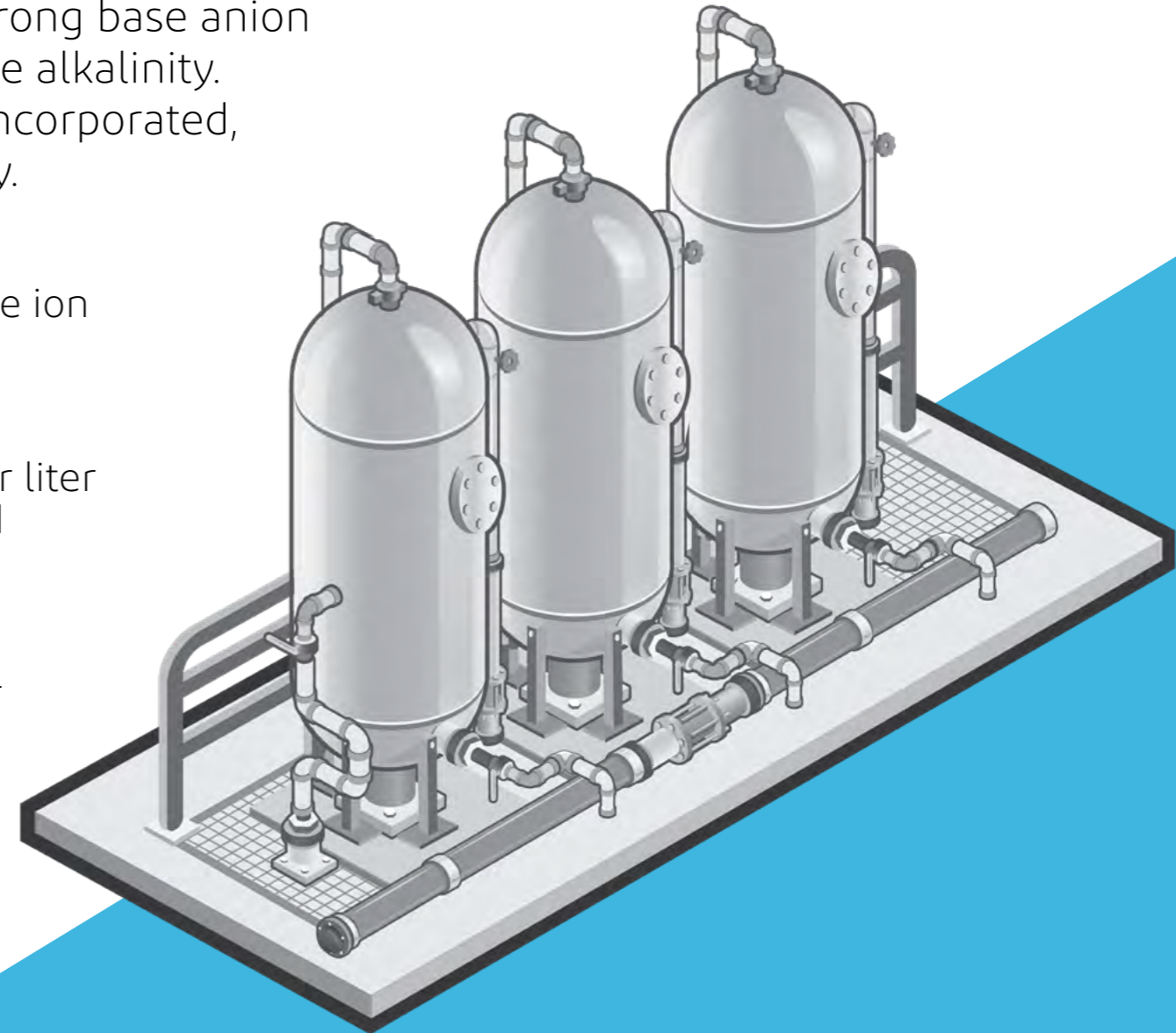
[BACK](#)[RECOMMENDED PRODUCTS](#)

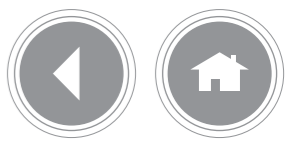

Ultrafiltration (UF)

Ultrafiltration technology removes colloids, particles and bacteria in a continuous system.

DuPont Unique: Provides the market's highest membrane active area, translating to smaller system footprint. All DuPont UF are made with high chemical resistance PVDF that reduces fouling and improves cleaning performance; providing higher system reliability and lower maintenance.

Benefits:

- Prevent or reduce fouling on demineralization unit, ideally used as a pre-treatment for downstream units like RO
- Reduce the impact of poor or highly variable source water on your boiler feedwater management
- Modularized, with a high level of automation and significantly smaller footprint than conventional filtration systems
- High recovery at 90-95%

The Numbers:

- Reduce RO cleaning needs by as much as 50% by using ultrafiltration as a pretreatment

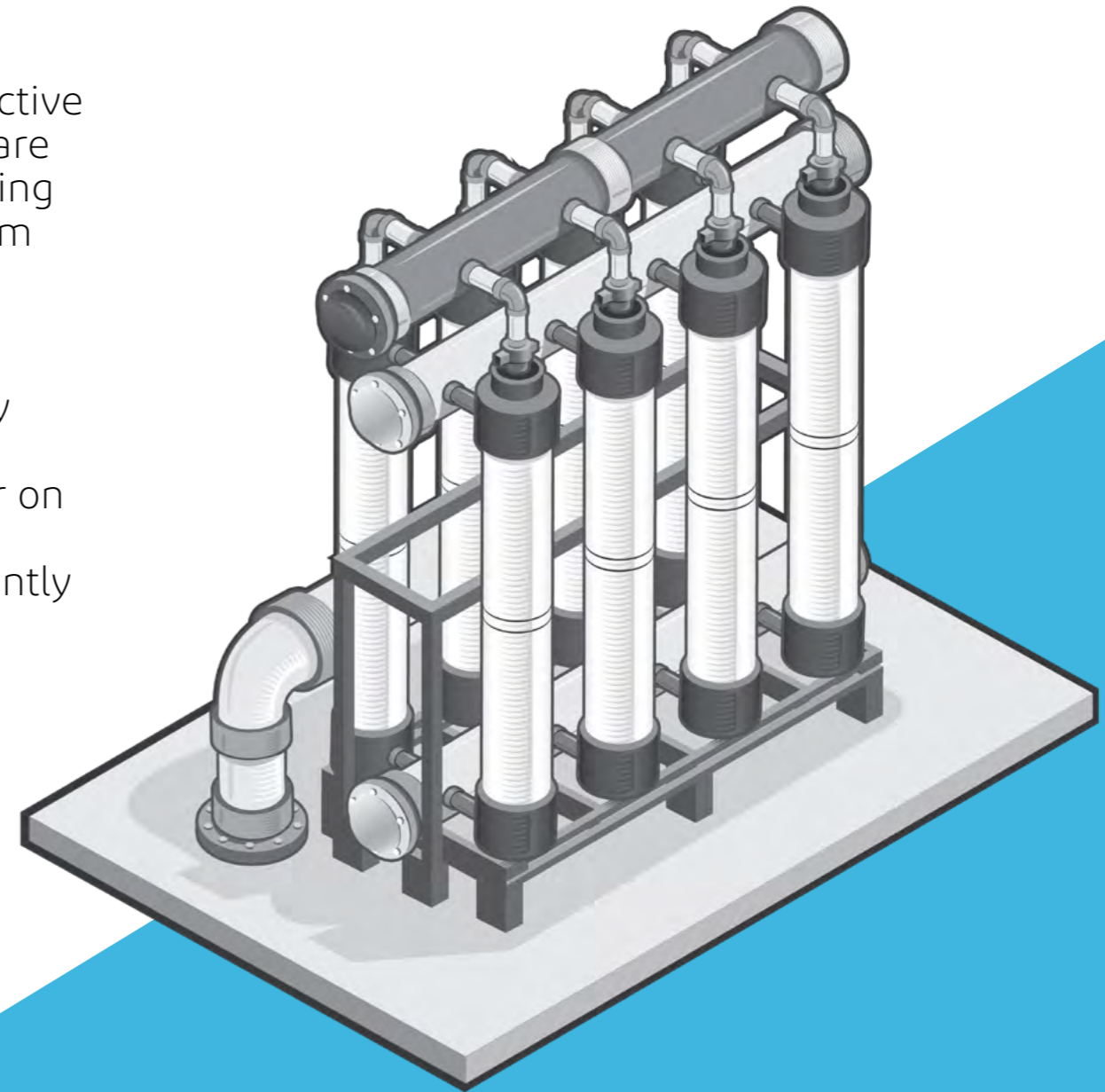
[BACK](#)[RECOMMENDED PRODUCTS](#)

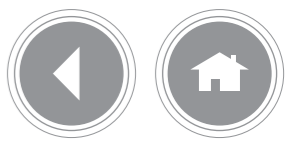

Ion Exchange (IX) Pretreatment

Purification technology that can work in high TDS/contaminant conditions to remove dissolved solids, total organic carbon, and other potential foulants.

DuPont Unique: Recognized world-leading ion exchange brand offer superior strength and quality. DuPont offers a comprehensive range of ion exchange resins to suit the most stringent water purity requirements and operating parameters.

Benefits:

- Prevent scaling in downstream RO and avoid the complication and expense of using antiscalants by incorporating softening resins to remove hardness from makeup water
- Protect RO and/or UF by using strong acid cation resins to help remove certain cationic polymers present from upstream coagulation systems
- Protect downstream softening and RO units with tailored strong base anion scavenging resins that remove certain organic species

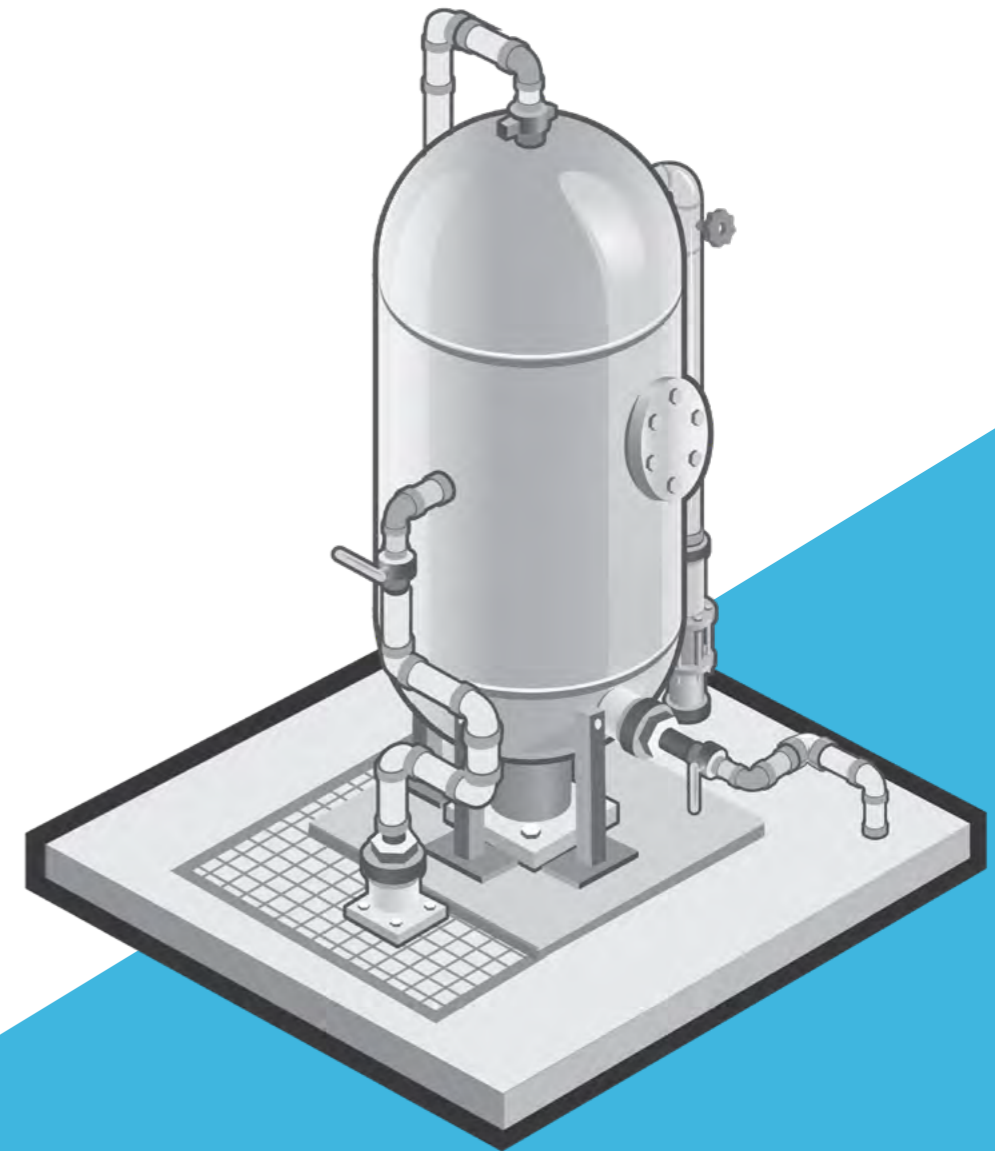
[BACK](#)[RECOMMENDED PRODUCTS](#)

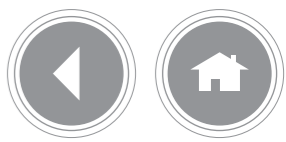

Reverse Osmosis/Nanofiltration (RO/NF)

Pressure driven filtration technology that removes molecules and ions from boiler makeup water. Removes down to a specific ion level (Ca, Mg, Fe, Si, Al).

DuPont Unique: Recognized world leader in RO and NF technologies for demineralizing brackish water or desalinating seawater.

Benefits:

- Prevent or reduce scalants, foulants and ions from entering the steam cycle
- Lower the blowdown rate and reduce total water intake
- Enable use of alternative feedwater sources, such as wastewater, to reduce overall water footprint
- Reduce the impact of poor or highly variable source water on your boiler water management
- Remove silica to reduce regeneration frequency of downstream IX MB

The Numbers:

- Reduce energy costs by over 30% by using high rejection, low energy innovative RO membrane technologies while improving water quality up to 40% against standard RO offerings

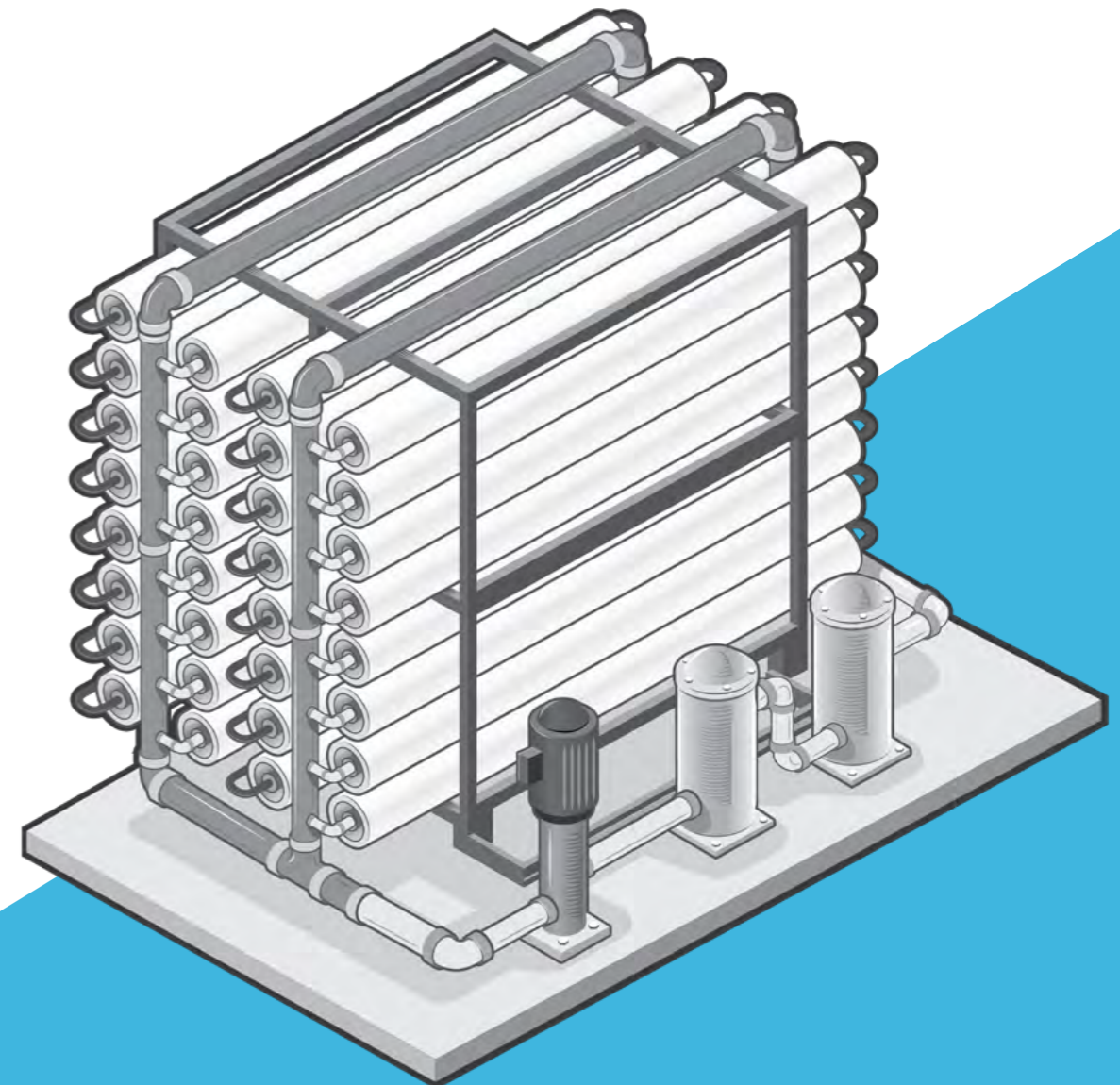
[BACK](#)[RECOMMENDED PRODUCTS](#)

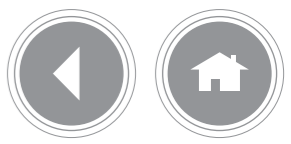

Ion Exchange Mixed Bed (IX MB)

Purification technology ideal to remove residual contaminants typically present in the low ppm to ppb range. IX MB is the standard final polishing step for boiler makeup.

DuPont Unique: A comprehensive range of uniform particle size (UPS) ion exchange resins, recognized for superior strength and quality, to suit the most stringent water purity and operating parameters for working and polishing mixed-beds.

Benefits:

- Great combination of trace contaminant removal, reliability, and cost effectiveness
- Optimize water quality with efficient regeneration and long life when using UPS MB resins with high kinetics and comparatively low pressure drop

The Numbers:

- Lower ionic leakage by 10-50% using UPS MB resins, resulting in longer run lengths (typically 10-30%) and higher water purity than most conventional MB resins

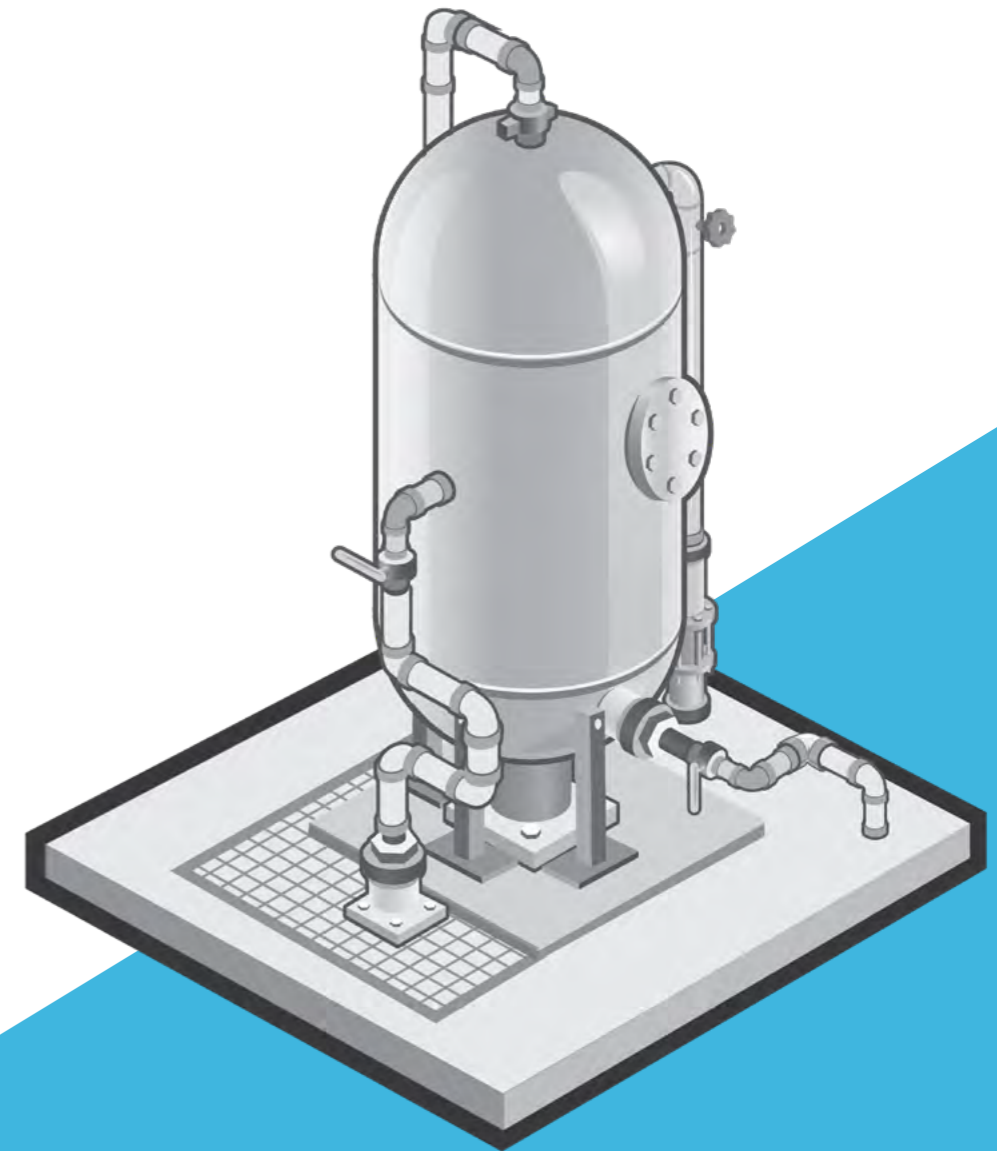
[BACK](#)[RECOMMENDED PRODUCTS](#)

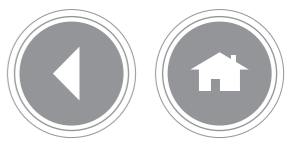

COOLING WATER MAKEUP

The right makeup for any water.

Don't let cooling water limit production. Meet any makeup water challenge with novel and advanced technologies.

SEE HOW

COMMON DESIGNS

RECOMMENDED PRODUCTS

Click on **technologies** to better understand their role in makeup water treatment.

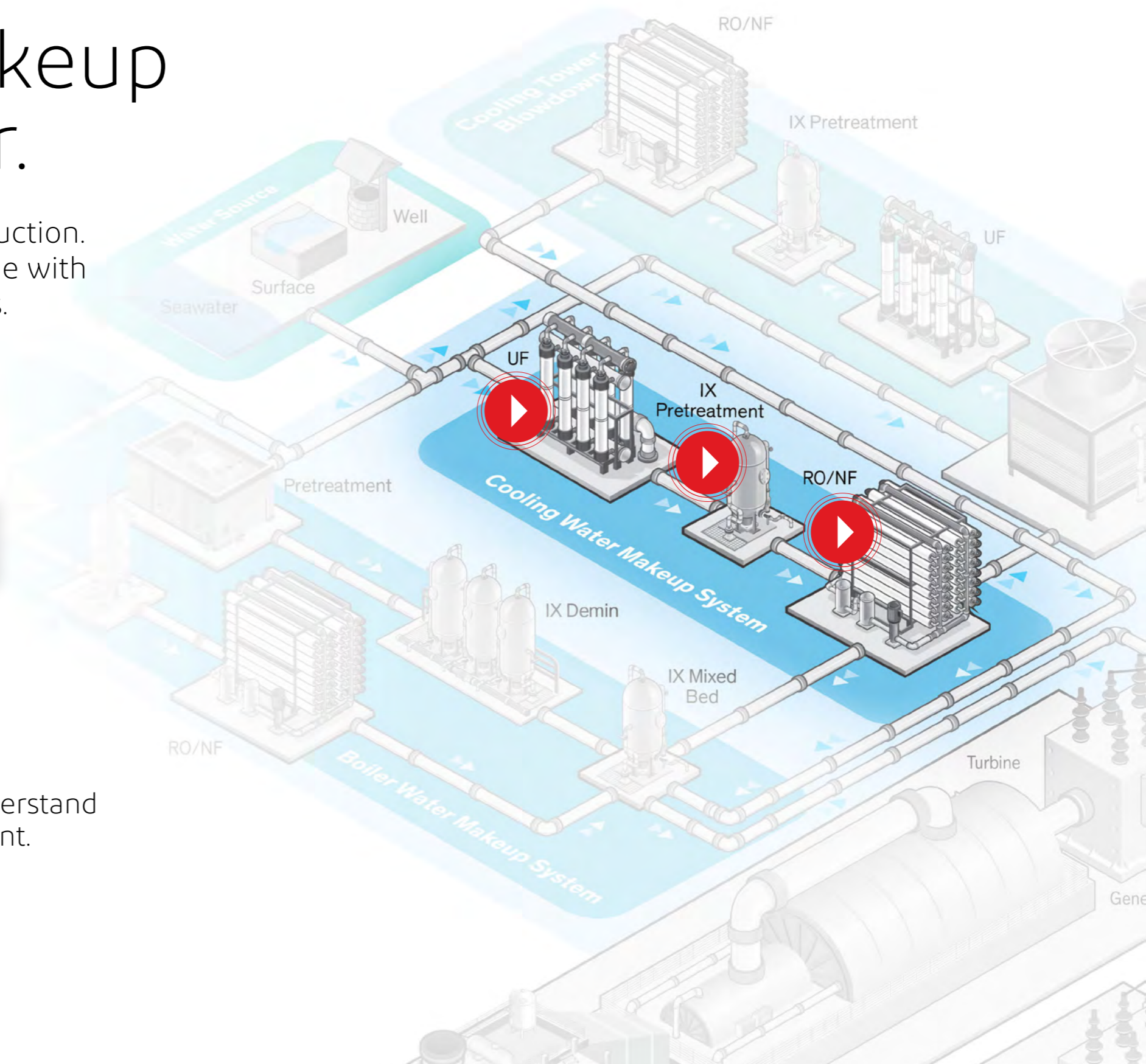



NATURAL GAS POWER PLANT • COOLING WATER MAKEUP

THE CHALLENGE



Cooling tower systems require a constant source of water due to losses from drift, evaporation, and blowdown. Depending on water source, region, and cooling tower type, several advanced filtration technologies and chemistries may be necessary to properly ready the make-up water before entering cooling tower system.

THE SOLUTION



DuPont can help you reduce corrosion, scale, biofouling, and other asset-limiting concerns no matter the fresh water source, abundance of water, and condition. We will work with you to determine an appropriate mix of technologies, including ultrafiltration (UF), reverse osmosis (RO), nanofiltration (NF), and ion exchange (IX).

BACK

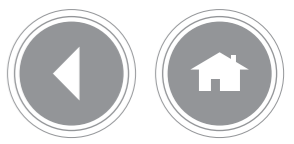

Common Designs

Cooling water makeup treatment is often combined with portions of a boiler makeup system. Designs incorporating ultrafiltration with reverse osmosis enable use of alternative sources, such as wastewater, for this stream.

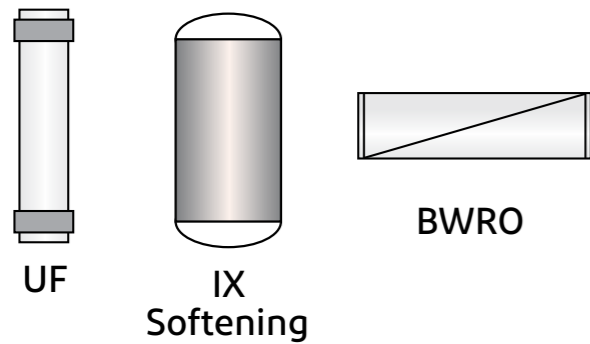

- Reduce cooling tower scale and corrosion
- Reuse of BWRO reject
- Higher RO recovery



- Colloidal and particulate removal

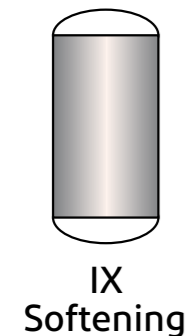

- Reduce cooling tower scale and corrosion

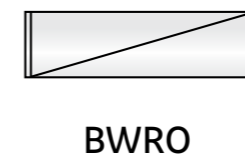

- Reduce cooling tower scale and corrosion

BACK

CONTACT AN EXPERT



Ultrafiltration (UF)

Ultrafiltration technology removes colloids, particles and bacteria in a continuous system.

DuPont Unique: Provides the market's highest membrane active area, translating to smaller system footprint. All DuPont UF are made with high chemical resistance PVDF that reduces fouling and improves cleaning performance; providing higher system reliability and lower maintenance.

Benefits:

- Reduce the impact of poor or highly variable source water on your cooling tower management
- Prevent or reduce fouling on demineralization unit, ideal to be used as a pre-treatment for downstream units like RO
- Modularized, with a high level of automation and significantly smaller footprint than conventional filtration systems
- High recovery at 90-95%

The Numbers:

- Reduce RO cleaning needs by as much as 50% when using ultrafiltration as a pretreatment

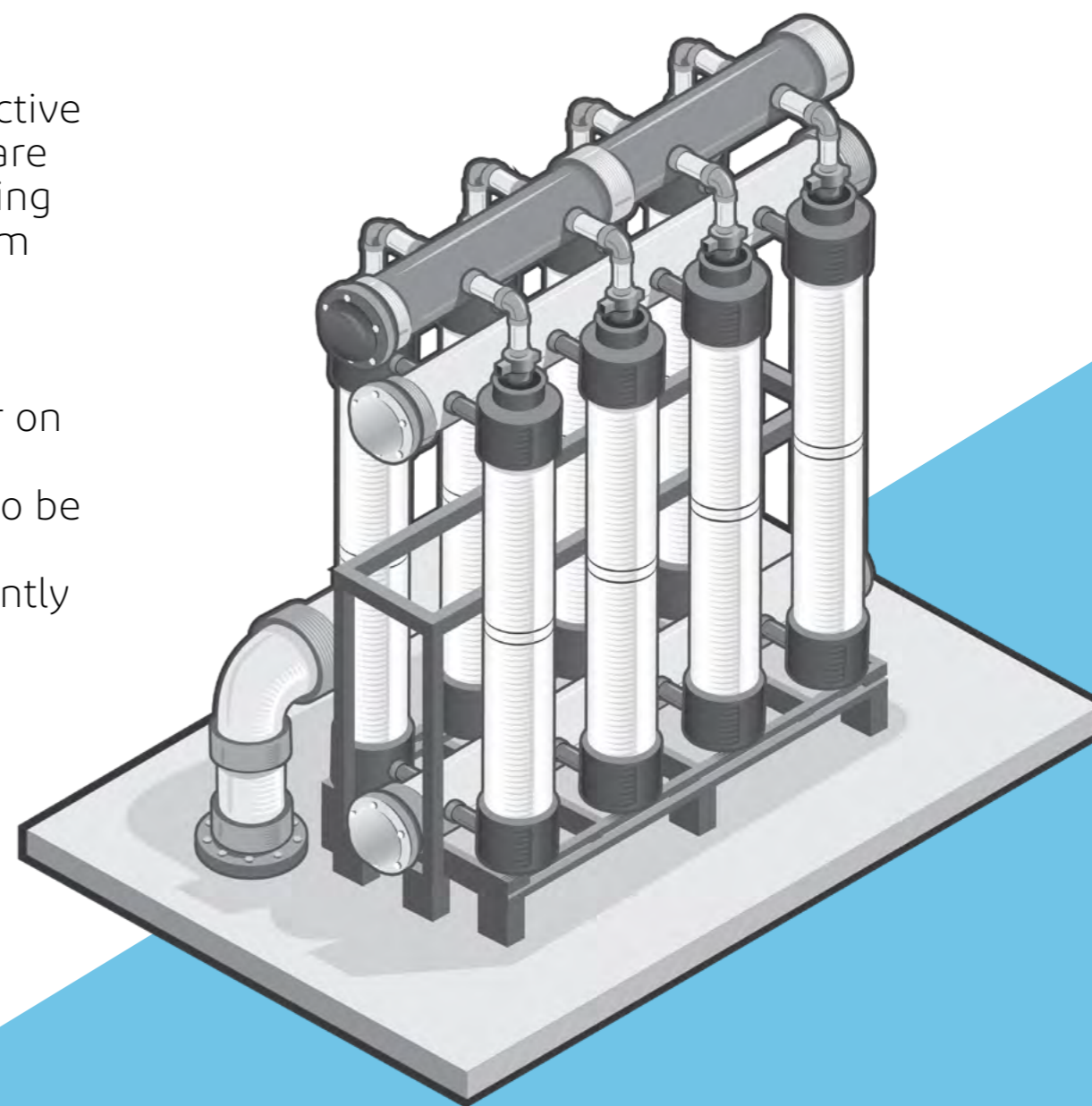
[BACK](#)[RECOMMENDED PRODUCTS](#)

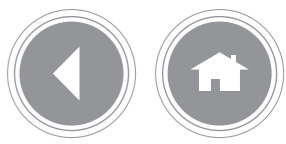

Ion Exchange (IX) Pretreatment

Purification technology that can work in high TDS/contaminant conditions to remove dissolved solids and total organic carbon.

DuPont Unique: Recognized world-leading ion exchange brand offer superior strength and quality. DuPont offers a comprehensive range of ion exchange resins to suit the most stringent water purity requirements and operating parameters.

Benefits:

- Prevent scaling in the cooling tower or downstream RO treatment and avoid the complication and expense of using antiscalants by incorporating softening resins to remove hardness from makeup water
- Strong and weak acid cation industrial softening resins can be tailored to fit your specific needs

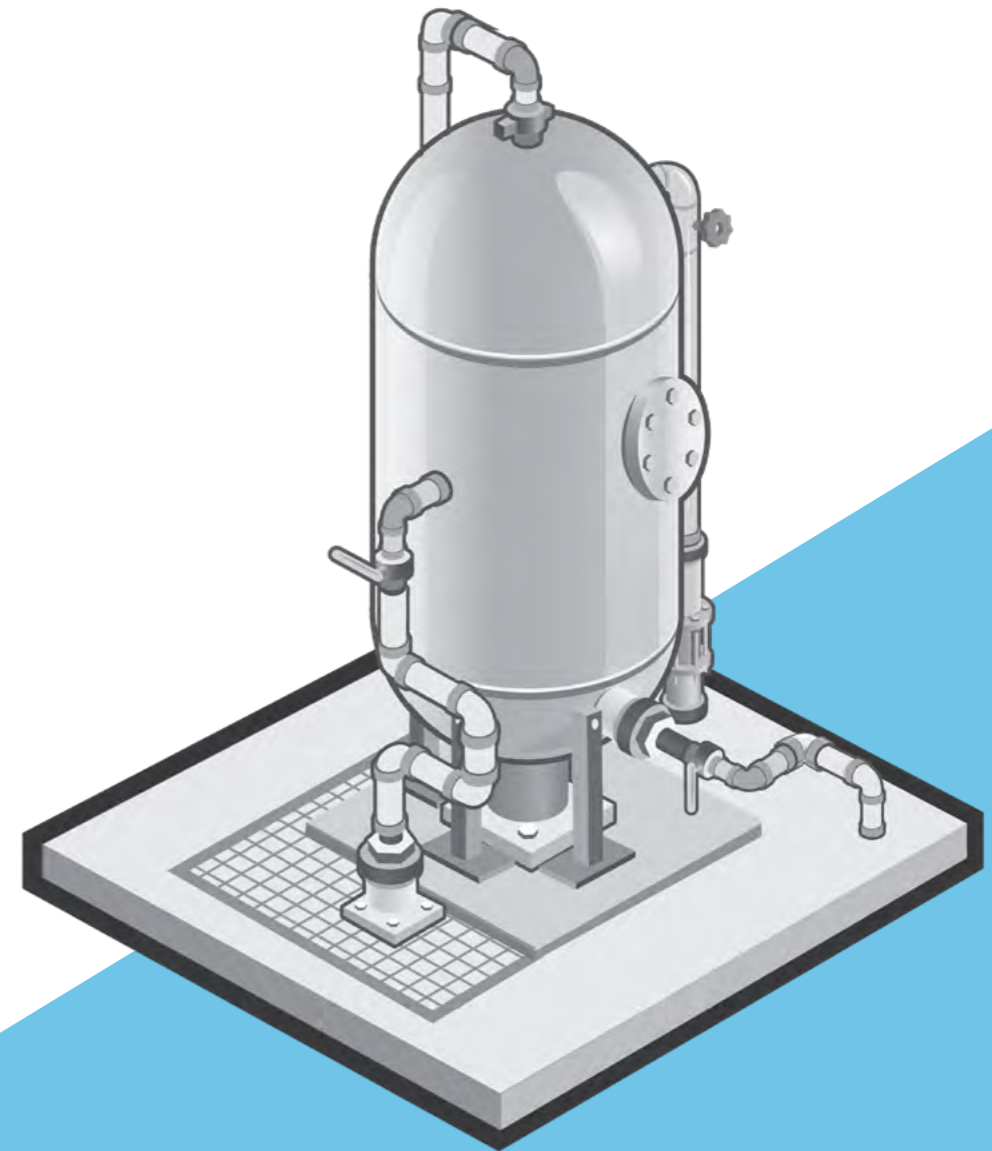
[BACK](#)[RECOMMENDED PRODUCTS](#)

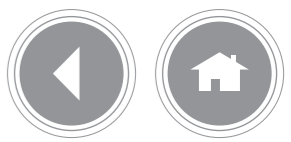

Reverse Osmosis/Nanofiltration (RO/NF)

Filtration technology that can remove many types of molecules and ions, down to a specific ion level (Ca, Mg, Fe, Si, Al).

DuPont Unique: Recognized world leader in RO and NF technologies for demineralizing brackish water or desalinating seawater.

Benefits:

- Prevent or reduce scalants, foulants and ions from entering cooling towers
- Increase number of cycles in cooling tower and reduce water intake
- Enable use of alternative feedwater sources, such as wastewater, to reduce overall water footprint
- Reduce amount of chemicals needed for cooling water control
- Reduce the impact of poor or highly variable source water on your cooling water management

The Numbers:

- Save 20-60% in water intake by recirculating your cooling tower twice as often

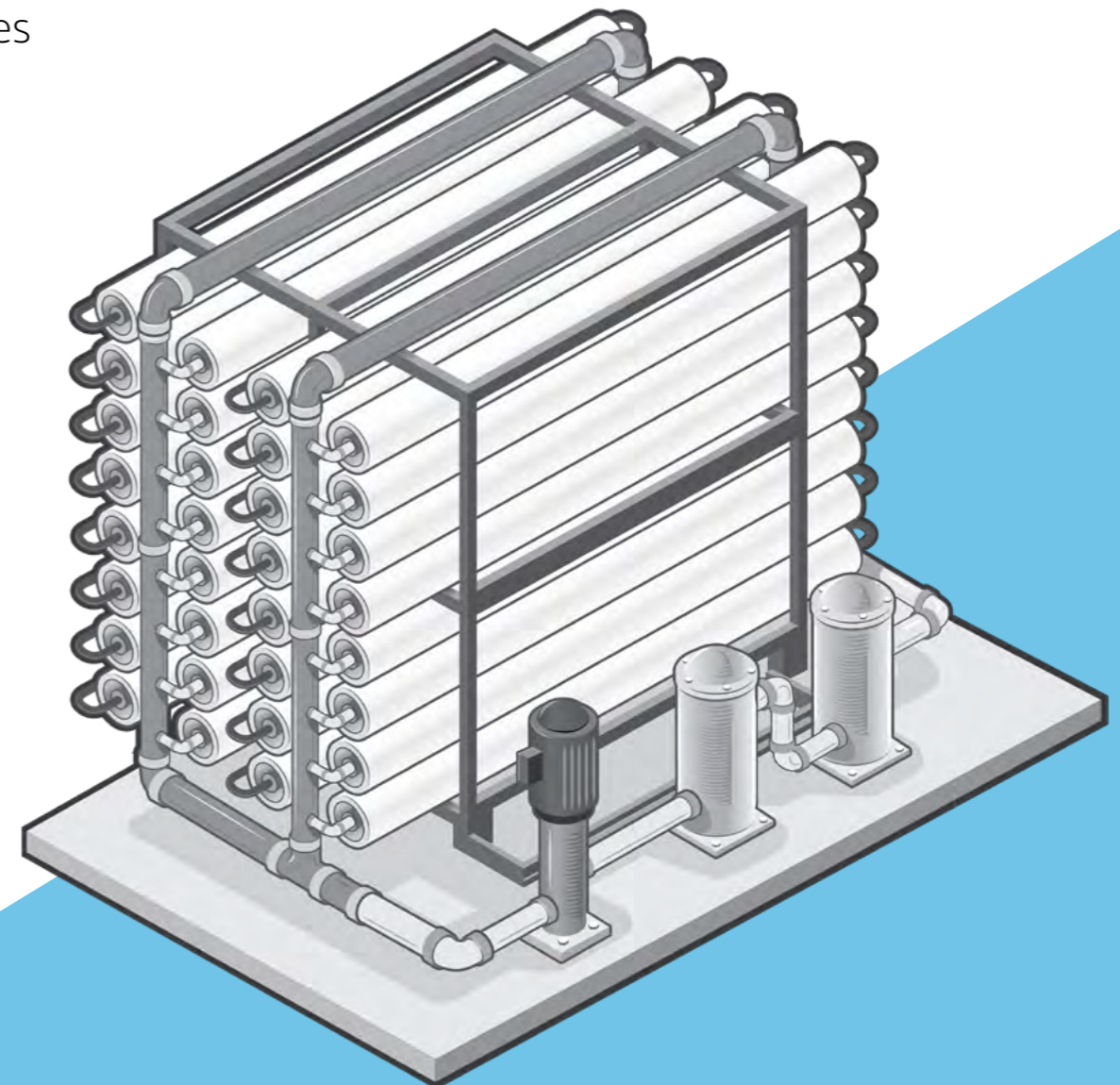
[BACK](#)[RECOMMENDED PRODUCTS](#)

COOLING TOWER BLOWDOWN

Keeping it cool.

Recover and reuse blowdown to meet compliance and minimize use of makeup water.

SEE HOW

COMMON DESIGNS

RECOMMENDED PRODUCTS

Click on technologies to better understand their role in blowdown treatment.

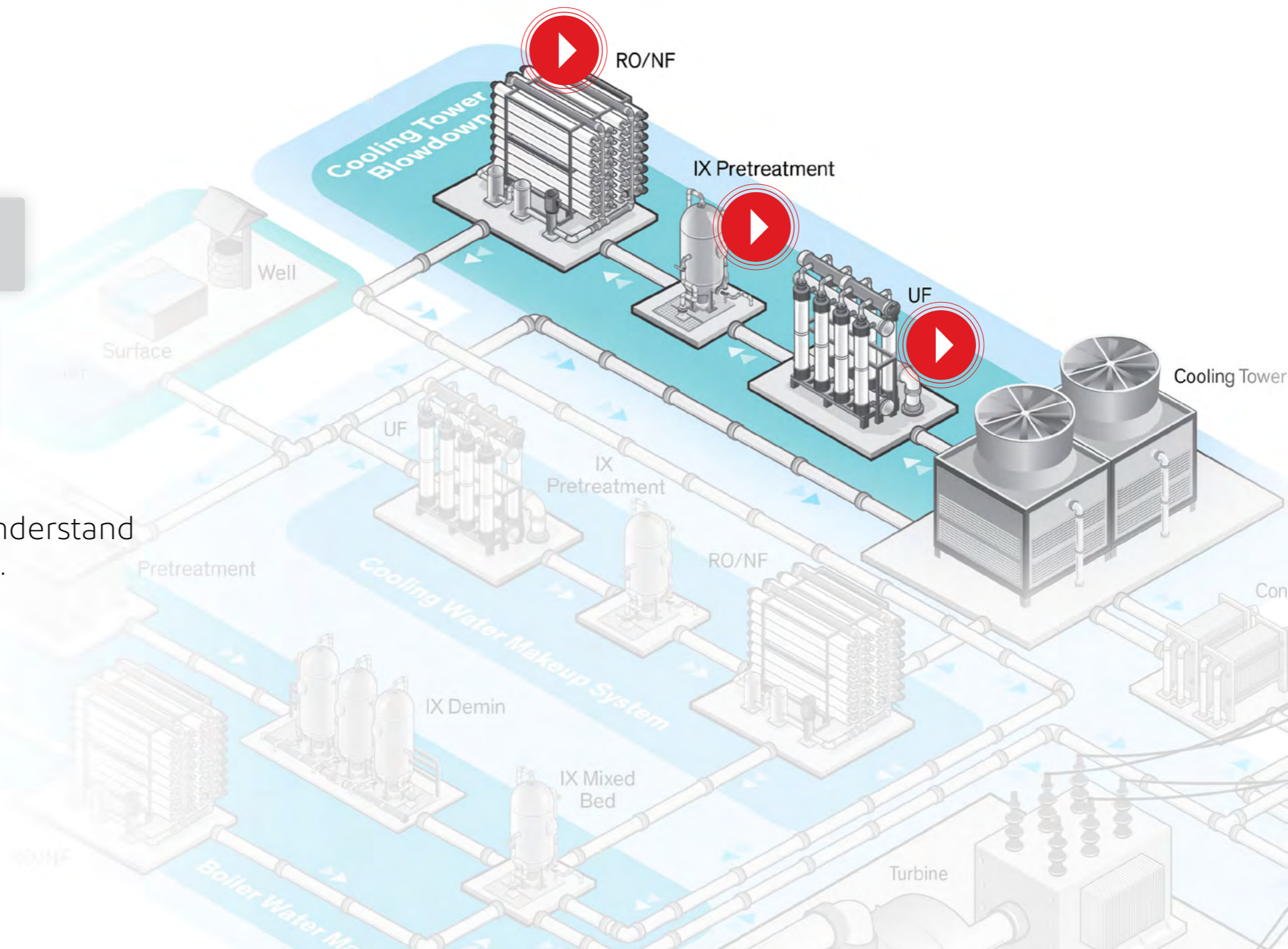



Keeping it cool

Recover
and m



NATURAL GAS POWER PLANT • COOLING TOWER BLOWDOWN

THE CHALLENGE



Recirculating cooling water lowers a power plant's withdrawal requirements but must be blown down periodically to prevent salt buildup as water evaporates in the towers. Because the blowdown is too dirty to be reused without treatment, it is typically sent directly to the wastewater treatment plant. This imposes a hydraulic load on the wastewater treatment system. More importantly, a tremendous amount of relatively clean water is wasted, adding significant cost and compliance complexity.

THE SOLUTION



Treatment and reuse of blowdown is becoming more common throughout the world as water scarcity drives policy decisions. DuPont experts work with you to deliver the optimal solution for your needs, using robust, reliable, fouling-resistant, filtration and purification technologies to recover and return up to 90% of blowdown water for makeup.

BACK

Click o
their r

Cooling Tower

Col

Turbine

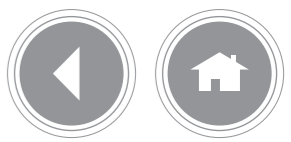











COOLING TOWER BLOWDOWN











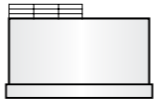

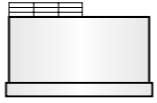

Common Designs

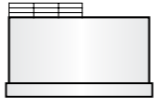
Cooling tower blowdown can vary by makeup source and pretreatment but is typically high in scaling and fouling potential. Mobile systems incorporating the compact unit operations in these designs are becoming more common in some regions.

Schemes incorporating only membranes can be used when the inlet hardness and/or the desired recovery are low.

Softening pre-treatment, via precipitation, ion exchange, or even both, may be required in more challenging waters with high hardness.

			• Low TDS	
				• Higher TDS
				• Higher TDS and temporary hardness

			• High hardness		
				• High hardness • Higher recovery • Large footprint	
					• High hardness • Maximum recovery
				• High hardness and/or higher TDS • Higher recovery • Smaller footprint	

BACK

CONTACT AN EXPERT

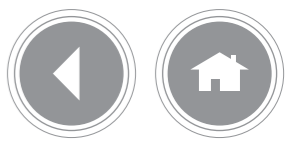

Ultrafiltration (UF)

Ultrafiltration technology removes colloids, particles and bacteria in a continuous system. It is optimally used in recycled water streams.

DuPont Unique: Provides the market's highest membrane active area, translating to smaller system footprint. All DuPont UF are made with high chemical resistance PVDF that reduces fouling and improves cleaning performance; contributing to higher system reliability and lower maintenance. Durable to withstand rigors of treating tough-to-clean cooling tower blowdown wastewater.

Benefits:

- Prevent or reduce fouling on CTBD treatment unit, ideally used as pre-treatment for operations like RO
- Reduce the impact of poor water quality on ability to recover and reuse CTBD
- Modularized, with a high level of automation and significantly smaller footprint than conventional filtration systems
- High recovery at 90-95%

The Numbers:

- Reduce RO cleaning needs by as much as 50% by using ultrafiltration as a pretreatment

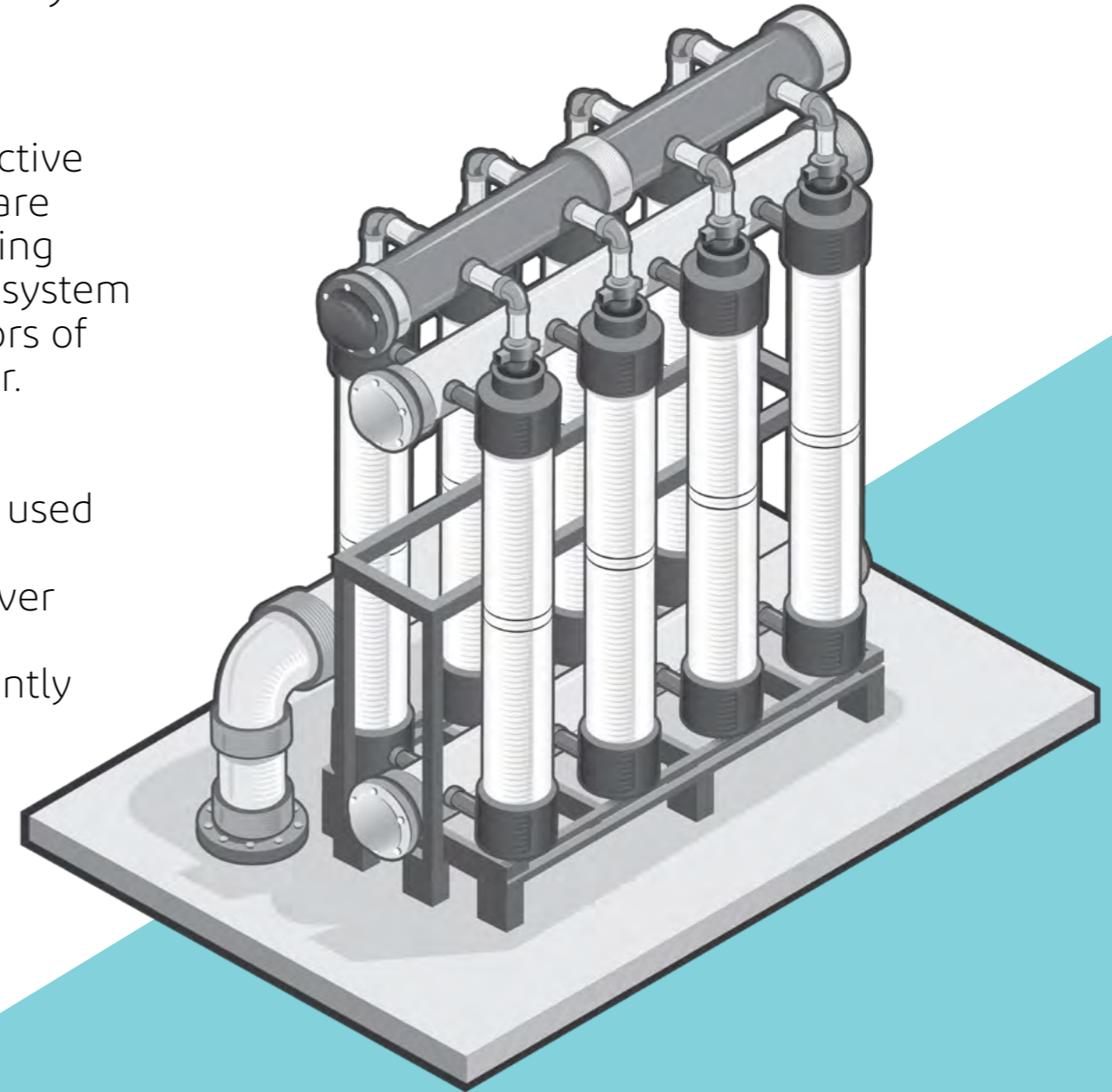
[BACK](#)[RECOMMENDED PRODUCTS](#)

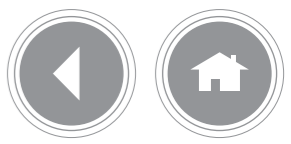

Ion Exchange (IX) Pretreatment

Purification technology that can work in high TDS/contaminant conditions to remove dissolved solids, total organic carbon, and other potential foulants.

DuPont Unique: Offers a comprehensive range of ion exchange resins, recognized for superior strength and quality, to suit your operational needs.

Benefits:

- Prevent scaling in the cooling tower circuit or downstream RO and avoid the complication and expense of using antiscalants by incorporating softening resins to remove hardness from blowdown
- Protect RO and/or UF by using strong acid cation resins to remove certain cationic polymers present from upstream coagulation systems
- Protect downstream softening and RO units with tailored strong base anion scavenging resins that remove certain organic species commonly found in CTBD wastewater

The Numbers:

- Realize up to 90% reuse of the cooling tower blowdown by adding industrial softening in front of dual membrane technology (UF + RO)

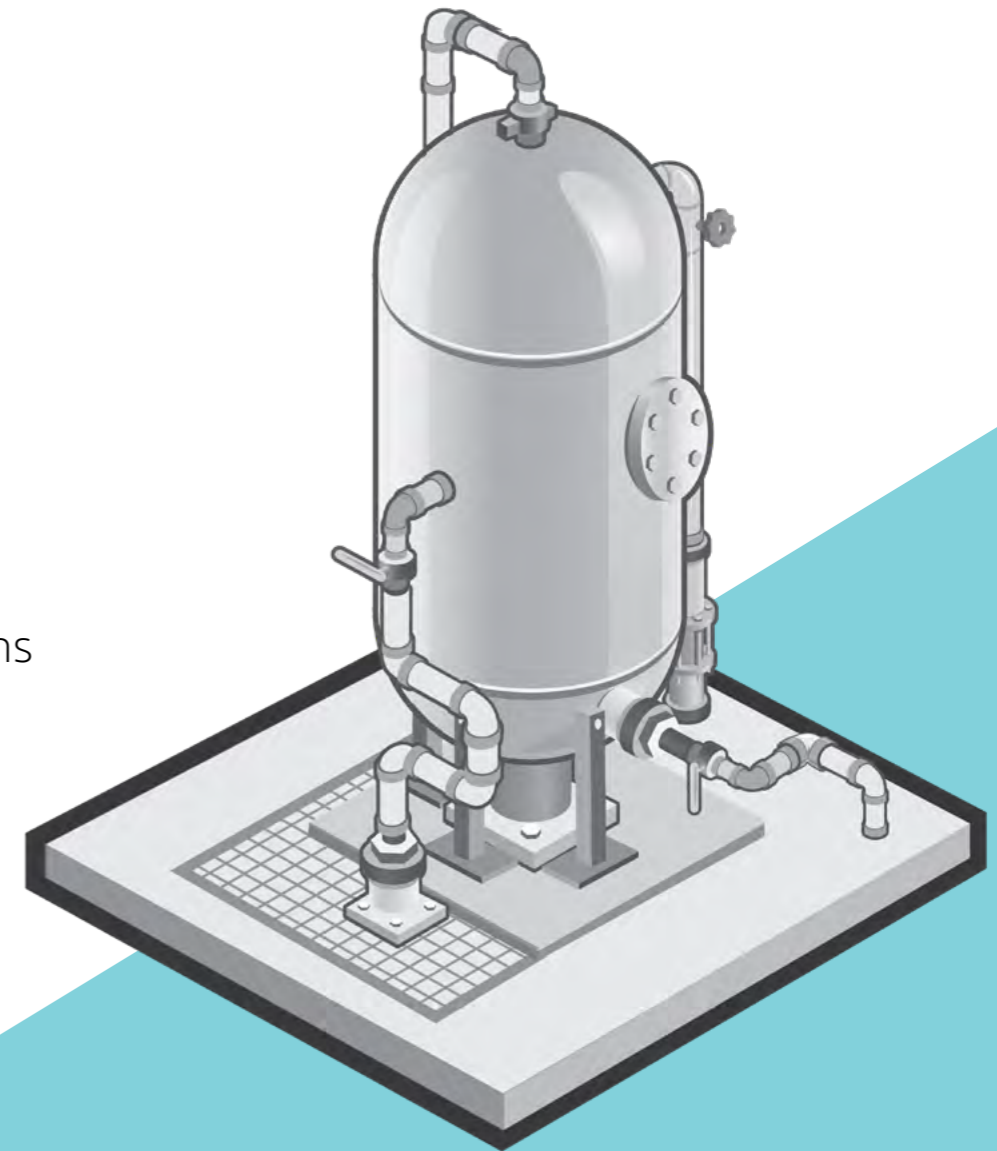
[BACK](#)[RECOMMENDED PRODUCTS](#)

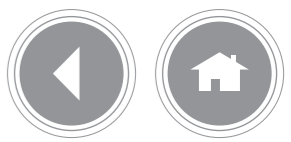

Reverse Osmosis/Nanofiltration (RO/NF)

Purification technology that can work in high TDS/contaminant conditions to remove dissolved solids, total organic carbon, and silica.

DuPont Unique: Recognized world leader in RO and NF technologies for demineralizing difficult-to-treat streams. Unique design and automated manufacturing makes them the market's most durable, fouling resistant, cleanable and reliable.

Benefits:

- Offers an ideal balance between efficient contaminant removal, demineralization, reliability and cost effectiveness
- Removes dissolved solids, silica, and total organic carbon prior to introducing water back into the cooling tower or boiler makeup system
- Tailored fouling resistant membranes handle high foulant loads from CTBD wastewater

The Numbers:

- Realize more than 70% reuse of the cooling tower blowdown when using dual membrane technology (UF + RO) together with proper pretreatment and chemical dosing

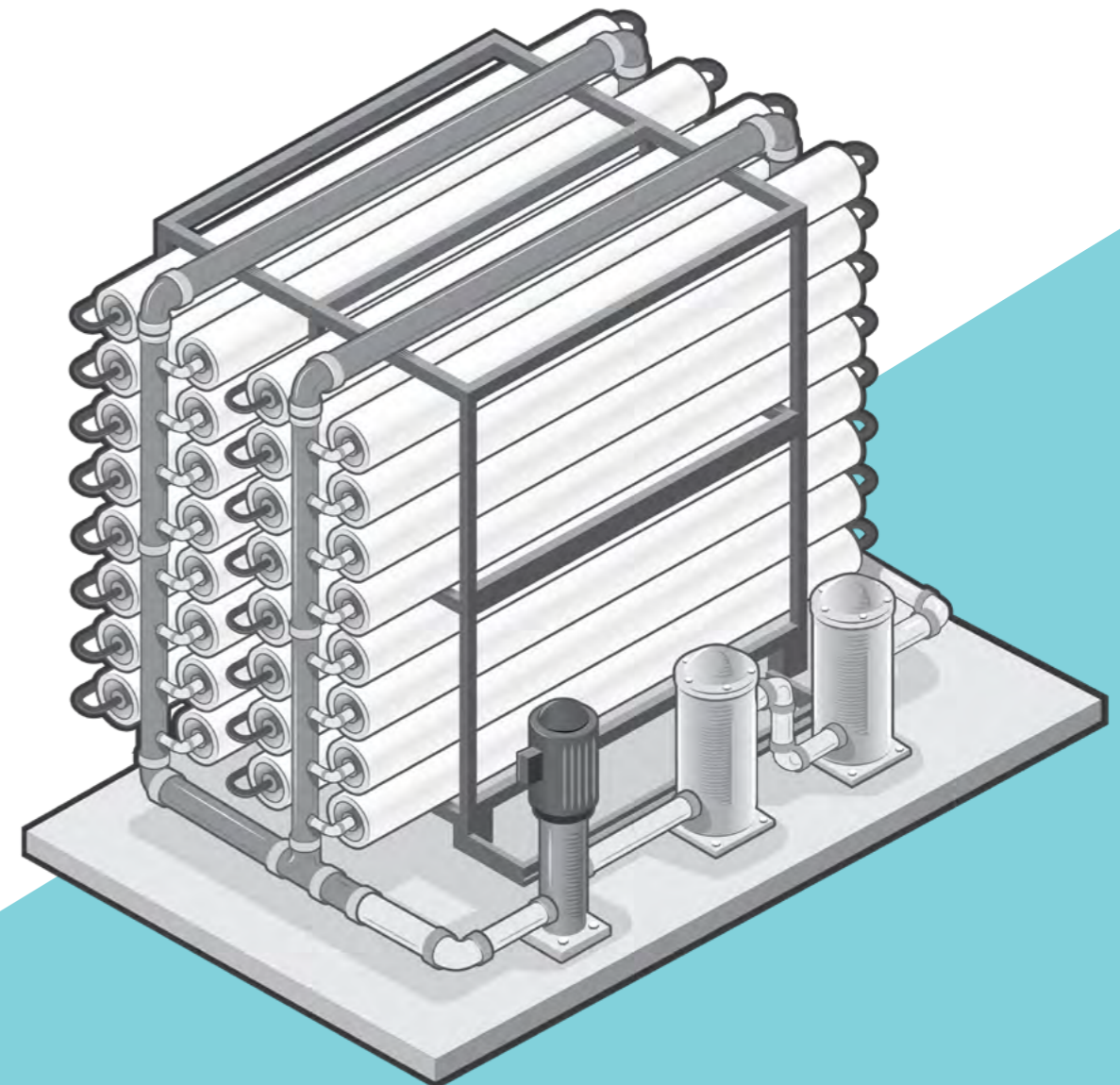
[BACK](#)[RECOMMENDED PRODUCTS](#)

CONDENSATE POLISHING

Keep your circuit clean and protected.

Remove trace contaminants and protect against condenser leaks.

SEE HOW

COMMON DESIGNS

RECOMMENDED PRODUCTS

Click on technologies to better understand their role in condensate polishing treatment.

IX Mixed Bed

IX Mixed Bed



Condensate Polishing Plant

Stator Cooling Treatment

Generator

Turbine

Generator



NATURAL GAS POWER PLANT • CONDENSATE POLISHING

THE CHALLENGE



The steam loop in natural gas designs must be maintained at a purity sufficient to prevent corrosion and protect against condenser leaks, which often necessitates the use of a condensate polishing plant. The plant must be optimized to the unique needs of each facility, as boiler design and amine chemistry can vary considerably from site to site. Amines added for corrosion control are also removed by the condensate polishing plant. For condensate polishing plants not running past the amine break, high amine removal capacity is desired to reduce regeneration frequency and keep operating costs low.

THE SOLUTION



Ion exchange condensate polishers protect critical power plant components and improve plant reliability. Regardless of the engineering design employed, the system is only as good as the ion exchange resins used. DuPont condensate polishing resins have been protecting valuable power plant assets and improving reliability throughout the world for decades. DuPont's portfolio of resins has several offerings specifically tailored to meet the challenging demands of condensate polishing.

BACK

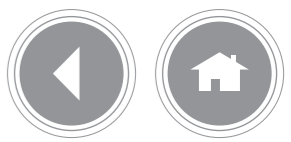

Common Designs

Several schemes using ion exchange resins can be found in NG condensate polishing, with prevalence often dictated by whether the plant is a conversion from a pre-existing coal-fired facility. These plants may be run past the amine break to reduce regeneration frequency.

Coal-fired conversions: Many of these facilities may utilize the existing water treatment footprint of the facility, including deep bed condensate polishers.

Combined Cycle Gas Turbine (CCGT): New facilities constructed strictly for natural gas combustion make less use of deep mixed beds, and may not always have a condensate polisher at all.

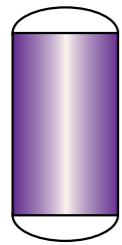

MB-H/OH

- Most common for heritage coal facilities

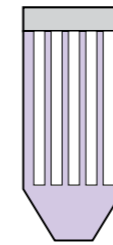

Powder
MB-(NH₄/OH or H/OH)

- Most common option if high purity water is required by the water cycle chemistry

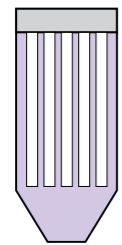

Powder
MB-(NH₄/OH or H/OH)

- Alternative with improved filtration



Powder
MB-H/OH

- Alternative with improved exchange capacity and condenser leak protection

BACK

CONTACT
AN EXPERT

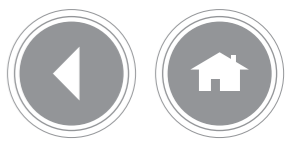

CONDENSATE POLISHING

Ion Exchange Mixed Bed (IX MB)

Purification technology ideal to remove residual contaminants typically present in the low ppm to ppb range. IX MB is the standard for steam condensate treatment.

DuPont Unique: Recognized world-leading IX brands offer superior strength and quality for high performance in working and polishing MB applications.

Benefits:

- Great combination of trace contaminant removal, oxidative stability, capacity and operational life
- Premium UPS gel/gel pair is engineered for low pressure drop, outstanding separation during regeneration, and long resin life
- Macroreticular anion resins provide high anion kinetics, excellent resistance to surface fouling and high osmotic stability

The Numbers:

- 20-30% longer run time and reduced corrosion during operation with DuPont's high capacity gel cation resin
- Improve fouling resistance with a specially formulated macroporous anion resin

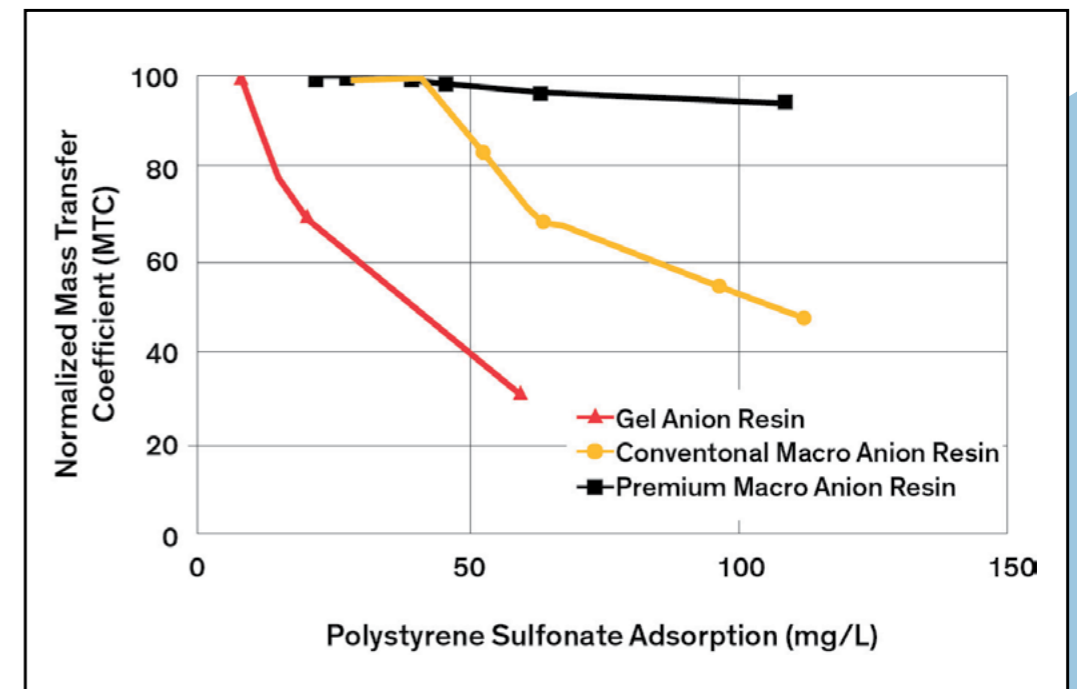

T. Ito, et al. A Quantum Leap in CPP Ion Exchange Resin Technology, 62nd International Water Conference, Pittsburgh, 2001.

[BACK](#)
[RECOMMENDED PRODUCTS](#)

STATOR COOLING TREATMENT

A cool generator is a happy generator.

Prevent corrosion of stator bars to help prevent failure of the generator.

SEE HOW

COMMON DESIGNS

RECOMMENDED PRODUCTS

Steam Turbine

Turbine

Genera

IX Mixed Bed

IX Mixed Bed

Stator Cooling Treatment

Click on **technologies** to better understand their role in stator cooling treatment.



NATURAL GAS POWER PLANT • STATOR COOLING

THE CHALLENGE



Stator bar overheating puts an electric generator at risk of reduced efficiency or even total failure. The temperature of the bars is maintained by a closed loop cooling water circuit, which is susceptible to both corrosion and particulate fouling, for example from copper oxides. Management of copper corrosion requires highly deionized cooling water and precise management of pH and oxygen levels.

THE SOLUTION



The stator cooling system is operated in one of two regimes to minimize copper corrosion: i) elevated pH/low oxygen (<50 ppb), or ii) elevated pH/high oxygen (>2 ppm). A mixed bed polisher removes both particulates and ions introduced into the loop through makeup and corrosion. An alkaline pH can be maintained by treating a portion of the circuit with a sodium form polishing bed.

BACK

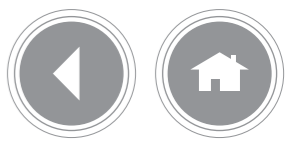

Common Designs

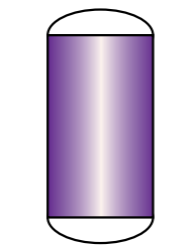

MB-H/OH

- Standard design, circuit purification

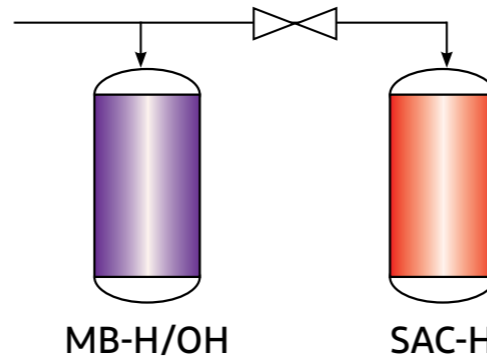

MB-H/OH

SAC-H

- Additional pH control to dissolve copper

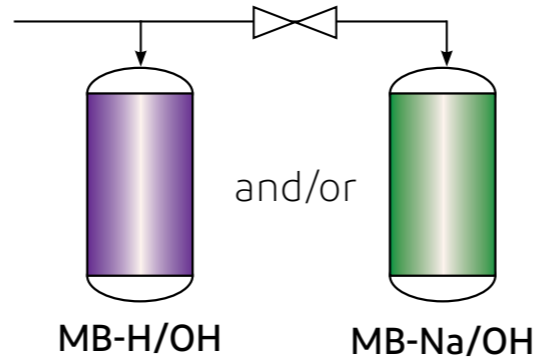

MB-H/OH

MB-Na/OH

- Circuit purification
- Na form cation resin for maintaining alkaline pH

[BACK](#)[CONTACT AN EXPERT](#)

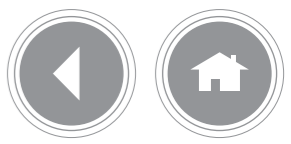

STATOR COOLING TREATMENT

Ion Exchange (IX)

Purification technology that removes residual contaminants at low levels.

DuPont Unique: Recognized world-leading ion exchange brands offer superior strength and quality for high performance applications. DuPont offers a comprehensive range of uniform particle size ion exchange resins to suit the most stringent water purity and operating parameters.

Benefits:

- Control the pH of the stator water through the optional use of a hydrogen form cation resin, allowing for the dissolution and removal of copper oxide to enhance heat transfer in the stator circuit
- Great balance between performance, efficiency and life time

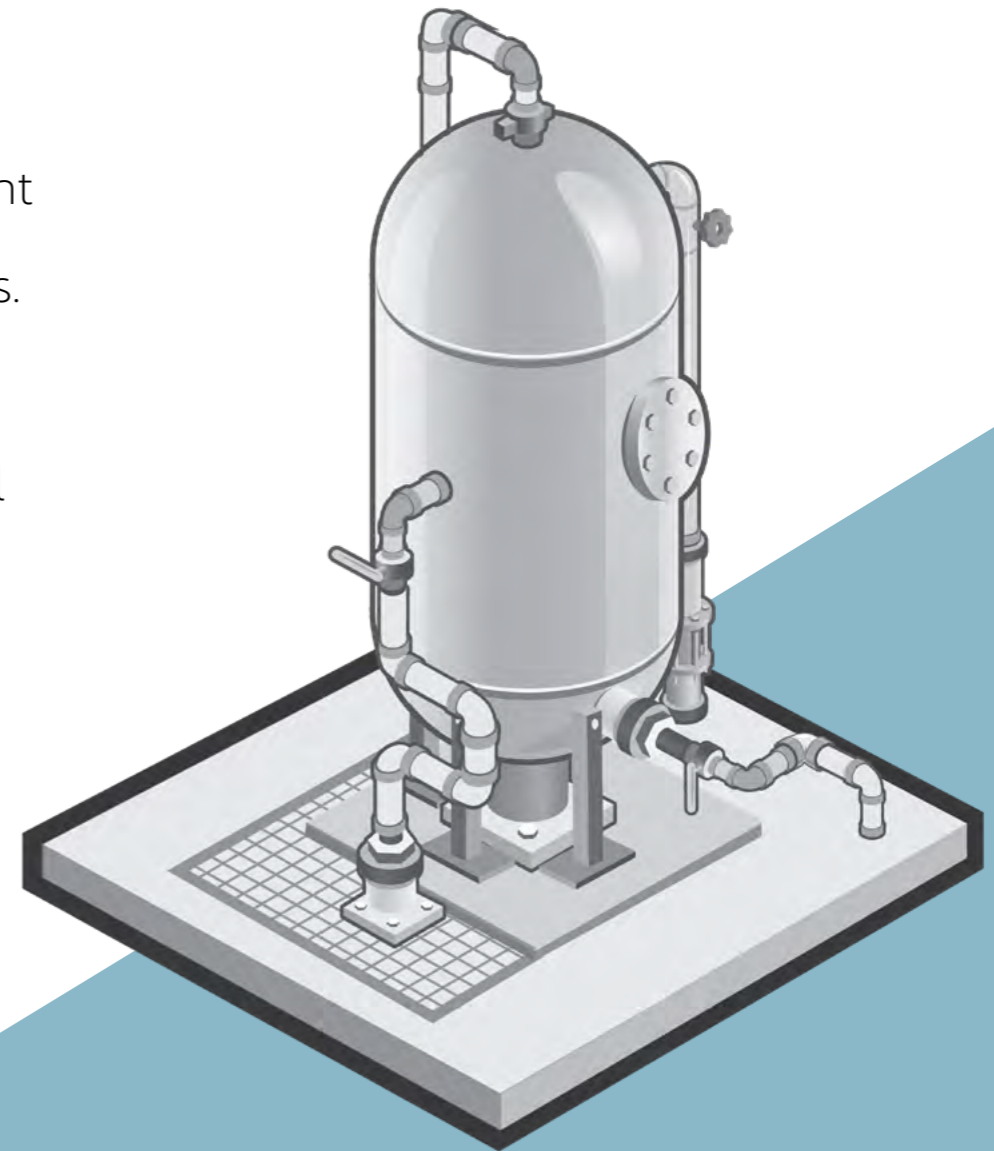
[BACK](#)[RECOMMENDED PRODUCTS](#)

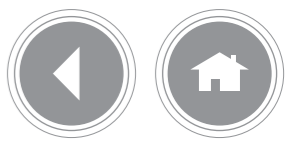

Ion Exchange Mixed Bed (IX MB)

Purification technology ideal for low TDS conditions to remove residual contaminants typically present in the low ppm to ppb range.

DuPont Unique: Recognized world-leading ion exchange brands offer superior strength and quality for high performance polishing mixed-bed applications.

Benefits:

- The most effective technology used to deionize stator cooling water
- Great balance between performance, stability, efficiency and life time, with uniform particle size resins that minimize pressure drop while optimizing separation for effective regeneration
- Elevate the stator water pH to prevent copper corrosion through use of a Na/OH form MB

The Numbers:

- Triple the lifetime of this MB and reduce the risk of premature or unexpected breakthrough when using the proper configuration with a high DVB cation resin

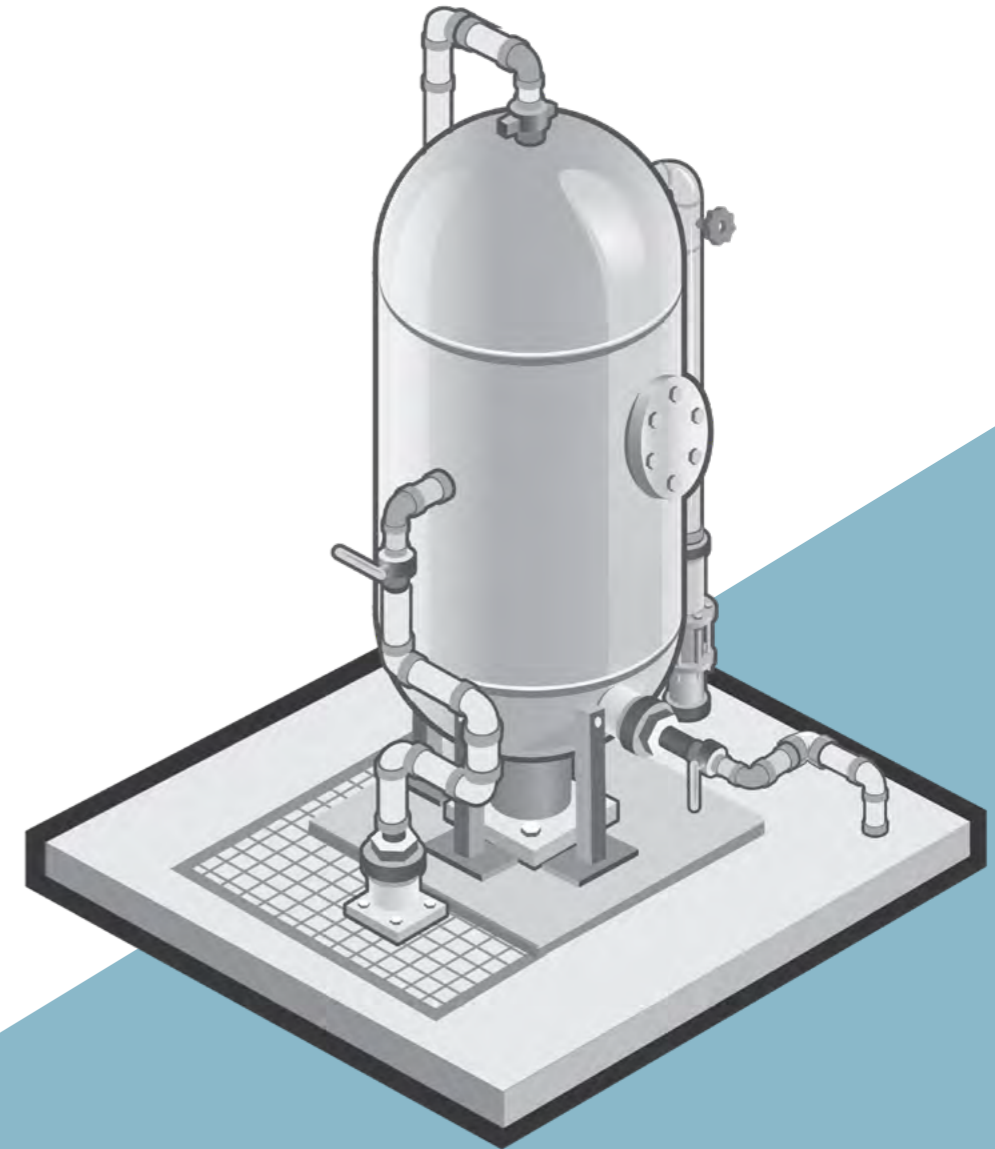
[BACK](#)[RECOMMENDED PRODUCTS](#)