

TECH SOLUTIONS 607.0 STYROFOAM™ BRAND HIGHLOAD INSULATION FOR FROST PROTECTION OF EXISTING UTILITY LINES



INTRODUCTION

STYROFOAM™ Brand HIGHLOAD Insulation and Buried Utility Lines

A severe winter freeze with deep frost penetration can damage existing underground utility lines, even when they are placed below the depth of normal frost penetration. Alternatively, ground surface construction activity involving soil cuts and/or grade reductions can lessen the amount of protective soil cover over these existing buried lines. This reduction in soil cover can lead to the eventual freeze-up of the utility lines if they are no longer buried below the level of expected frost penetration. However, there is a cost-efficient solution: STYROFOAM™ Brand HIGHLOAD 40, 60 and 100 Extruded Polystyrene Insulation.

STYROFOAM™ Brand HIGHLOAD Insulation is a rigid, extruded polystyrene foam insulation board. With integral high-density skins, STYROFOAM™ Brand HIGHLOAD Insulation has excellent resistance to ground moisture and freeze-thaw cycling. Specifically designed for in-ground applications, STYROFOAM™ Brand HIGHLOAD Insulation is available in 40 psi, 60 psi and 100 psi (275 kPa, 415 kPa and 690 kPa) compressive strengths to resist a variety of applied loads.

One common solution to protect buried utility lines from the damaging effects of frost, short of complete replacement, is to place a layer of STYROFOAM™ Brand HIGHLOAD Insulation 6" (150 mm) above the utility line. While well-suited for protection of newly placed shallow utility lines, such practice is often prohibitive when dealing with existing lines due to the extensive excavation and removal of overburden required. This information sheet discusses using STYROFOAM™ Brand HIGHLOAD Insulation where:

- existing utility lines have freezing problems
- the insulation layer **cannot** be placed relatively close to the top of the utility line

Through research, many design charts have been developed that show how to tackle these conditions without excavating completely to the utility line. The three included nomograms are from "Frost Protection of Buried Water and Sewage Pipes: Three Articles" by P. Gunderson, Norwegian Building Institute, Oslo, 1976.

For more information on how STYROFOAM™ Brand HIGHLOAD Insulation can benefit existing utility lines, contact your Dow representative.

Installing STYROFOAM™ Brand HIGHLOAD Insulation is a cost- and labor-saving way to protect existing utility lines. Offering the option of not digging completely to the buried line, the insulation can be laid in less time.

USING THE NOMOGRAMS

To use the nomograms, you will need to know the following information:

- annual mean air temperature in degrees °F (degrees °C)
- design freezing index in degree-hours °F (degree-hours °C)

These nomograms are for utility lines with: a small flow of water, long operational interruptions, or where the supply of heat may be deficient for other reasons. For example, use these nomograms for the protection of water pipelines in thinly populated areas or in vacation areas where they are irregularly used. They can also be used to protect service lines from water mains to individual houses.

STYROFOAM™ BRAND HIGHLOAD INSULATION FOR FROST PROTECTION OF EXISTING UTILITY LINES

Figure 1: Sand or Gravel – Horizontal Insulation

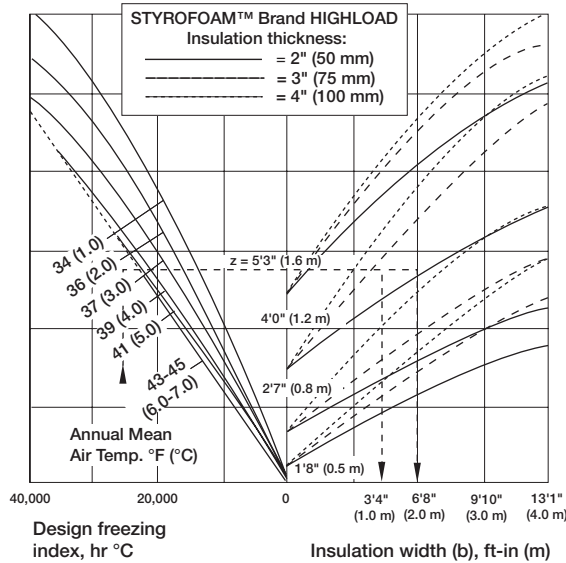
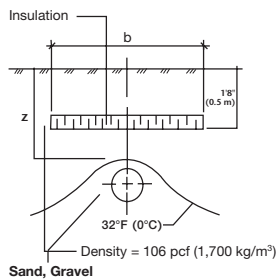
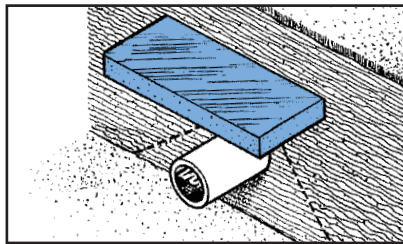

Insulation width and thickness required to limit frost depths to 1'8", 2'7", 4'0" and 5'3" (0.5 m, 0.8 m, 1.2 m and 1.6 m) directly below horizontal insulation, given different design freezing indices. The ground material is sand or gravel.

Note: To convert design freezing index from degree-hours °C to degree-hours °F, multiply by 1.8. To convert design freezing index from degree-hours to degree-days, divide by 24.

Figure 2: Clay – Horizontal Insulation

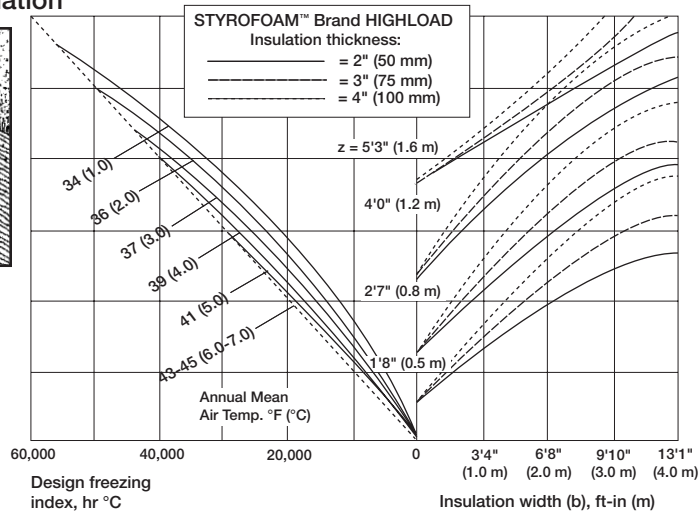
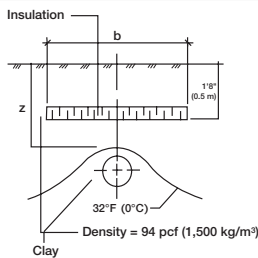
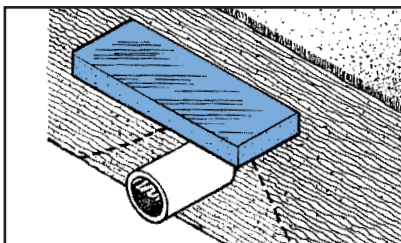

Insulation width and thickness required to limit frost depths to 1'8", 2'7", 4'0" and 5'3" (0.5 m, 0.8 m, 1.2 m and 1.6 m) directly below horizontal insulation, given different design freezing indices. The ground material is clay.

Note: To convert design freezing index from degree-hours °C to degree-hours °F, multiply by 1.8. To convert design freezing index from degree-hours to degree-days, divide by 24.

STYROFOAM™ BRAND HIGHLOAD INSULATION FOR FROST PROTECTION OF EXISTING UTILITY LINES

Figure 3: Sand or Gravel – Inverted “U” Insulation

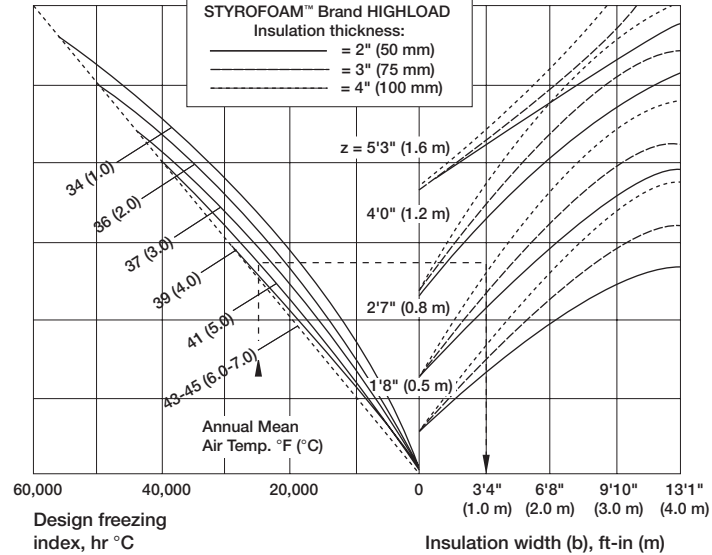
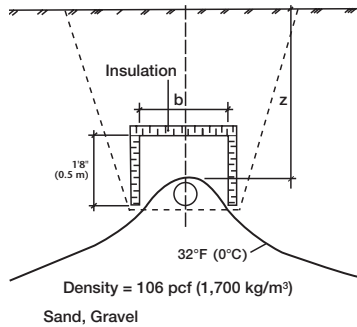
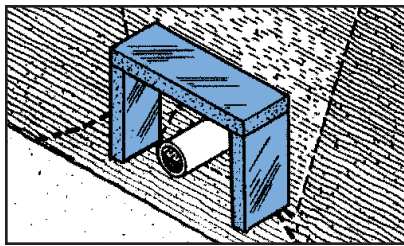

Insulation width and thickness required to limit frost depths to 1'8", 2'7", 4'0" and 5'3" (0.5 m, 0.8 m, 1.2 m and 1.6 m) directly below inverted "u" insulation, given different design freezing indices. The ground material is sand or gravel.

Note: To convert design freezing index from degree-hours °C to degree-hours °F, multiply by 1.8. To convert design freezing index from degree-hours to degree-days, divide by 24.

IN THE U.S. AND CANADA:

For Technical Information: 1-866-583-BLUE (2583) (English) 1-800-363-6210 (French)

For Sales Information: 1-800-232-2436 (English) 1-800-565-1255 (French)

THE DOW CHEMICAL COMPANY . Dow Building Solutions . 200 Larkin . Midland, MI 48674

DOW CHEMICAL CANADA ULC . Dow Building Solutions . 450 – 1st St. SW . Suite 2100 . Calgary, AB T2P 5H1

www.dowbuildingsolutions.com

NOTICE: No freedom from any patent owned by Dow or others is to be inferred. Because use conditions and applicable laws may differ from one location to another and may change with time, Customer is responsible for determining whether products and the information in this document are appropriate for Customer's use and for ensuring that Customer's workplace and disposal practices are in compliance with applicable laws and other government enactments. Dow assumes no obligation or liability for the information in this document. NO EXPRESS WARRANTIES ARE GIVEN EXCEPT FOR ANY APPLICABLE WRITTEN WARRANTIES SPECIFICALLY PROVIDED BY DOW. ALL IMPLIED WARRANTIES INCLUDING THOSE OF MERCHANTABILITY AND FITNESS FOR A PARTICULAR PURPOSE ARE EXPRESSLY EXCLUDED.

CAUTION: This product is combustible. Protect from high heat sources. A protective barrier or thermal barrier may be required as specified in the appropriate building code. For more information, consult MSDS, call Dow at 1-866-583-BLUE (2583) or contact your local building inspector. In an emergency, call 1-989-636-4400 in the U.S. or 1-519-339-3711 in Canada.

Building and/or construction practices unrelated to building materials could greatly affect moisture and the potential for mold formation. No material supplier including Dow can give assurance that mold will not develop in any specific system.

Republished November 2008

