



## Product Data Sheet

### DuPont™ AmberSorb™ L493 and V493 Polymeric Adsorbents

Industrial-grade Adsorbents for Concentrating Organics from Water and Air

#### Description

DuPont™ AmberSorb™ L493 and V493 Polymeric Adsorbents are a highly crosslinked styrenic polymer that is insoluble in strong acid, strong base, or organic solvents. They have high pore volume (1.16 cc/g) and high surface area (~1100 m<sup>2</sup>/g), as well as a unique pore size distribution (Figure 1).

These polymeric adsorbent resins have been developed for the concentration of organics from water and air. Key features of AmberSorb™ L493 and V493:

- Highly crosslinked polymer matrix
- Unique pore size distribution
- High surface area
- Improved capacity for organic compounds
- Hydrophobic adsorbent surface
- Non-catalytic activity
- Spherical beads with good physical strength

**AmberSorb™ L493 Polymeric Adsorbent** is supplied in the wet form and is intended for liquid applications.

**AmberSorb™ V493 Polymeric Adsorbent** is supplied in the dry form and is intended for vapor applications.

The wet material is easily dried in a flowing stream of air at ambient temperature.

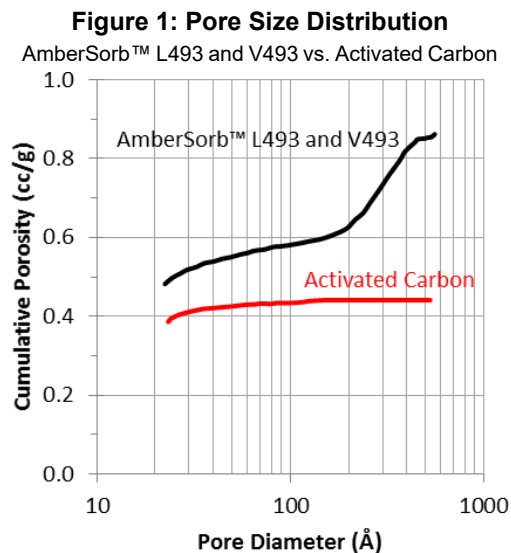

## Applications

- Removal of organics from water
- Removal of volatile organic compounds (VOC) and hazardous air pollutants (HAP) from air

## Typical Properties

	DuPont™ AmberSorb™ L493	DuPont™ AmberSorb™ V493
<b>Physical Properties</b>		
Copolymer	Styrene-divinylbenzene	Styrene-divinylbenzene
Matrix	Macroporous	Macroporous
Type	Adsorbent	Adsorbent
Functional Group	None	None
Physical Form	Tan to brown, opaque, spherical beads	Orange to brown, opaque, spherical beads
Heat Capacity	0.75 cal/(g °C)	0.30 cal/(g °C)
Thermal Conductivity	0.00033 cal/(s cm °C)	0.00016 cal/(s cm °C)
<b>Nitrogen BET</b>		
Surface Area	~1100 m <sup>2</sup> /g	~1100 m <sup>2</sup> /g
Total Pore Volume	~1.16 cc/g	~1.16 cc/g
Average Pore Diameter	~46 Å	~46 Å
<b>Chemical Properties</b>		
Ionic Form as Shipped	Not applicable	Not applicable
Total Exchange Capacity	Not applicable	Not applicable
Water Retention Capacity	50 – 65%	≤ 5%
<b>Particle Size</b> <sup>§</sup>		
Particle Diameter	300 – 840 µm	300 – 840 µm
< 300 µm	≤ 3%	≤ 3%
> 1180 µm	≤ 2%	≤ 2%
<b>Purity</b>		
Ash Content	≤ 0.01%	≤ 0.01%
<b>Stability</b>		
Whole Beads	≥ 90%	≥ 90%
Friability:		
Average	≥ 500 g/bead	≥ 500 g/bead
<b>Density</b>		
Shipping Weight	620 g/L	340 g/L

<sup>§</sup> For additional particle size information, please refer to the [Particle Size Distribution Cross Reference Chart](#) (Form No. 45-D00954-en).

## Hydraulic Characteristics

Pressure drop due to fluid flow through an adsorbent bed is an important design consideration.

The pressure drop for water flowing through a bed of DuPont™ AmberSorb™ L493 Polymeric Adsorbent is given by the equation:

$$\Delta P / L = k \mu F$$

where:

$\Delta P / L$  = pressure drop per distance through the packed bed in psi/ft

$k = 0.15$

$\mu$  = viscosity of water in cP

$F$  = linear flowrate in gpm/ft<sup>2</sup>

For air flow through a packed bed of AmberSorb™ V493 Polymeric Adsorbent, estimated pressure drop as a function of air velocity, downflow through a packed bed, is shown in Figure 2. In upflow applications, AmberSorb™ V493 will begin to fluidize at an air velocity of about 10 ft/min.

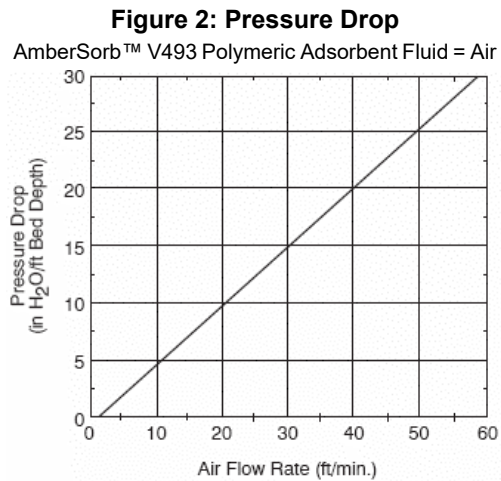

## Application Information

### Liquid Applications using AmberSorb™ L493 Polymeric Adsorbent

AmberSorb™ L493 Polymeric Adsorbent is an excellent choice for removal of certain organics from water. Because of its unique pore size distribution, it has high capacity for organics and good desorption characteristics.

Adsorption forces are generally weak and heavily influenced by the properties of the matrix (pH, temperature, ionic strength, etc.). Equilibrium isotherm testing is a convenient, time-saving way to screen adsorption media for specific applications.

**Application Information (Cont.)**

An easy-to-follow guide for generating isotherms is available – see [Equilibrium Isotherm Testing for Liquid Phase Applications](#)” (Form No. 45-D01091-en). As an example, results of an equilibrium adsorption isotherm study are shown in Figure 3 for the removal of phenol from a solution at pH 6.0 with AmberSorb™ L493.

**Figure 3: Equilibrium Adsorption Isotherm**

AmberSorb™ L493 Polymeric Adsorbent Phenol in water @ pH = 6.0

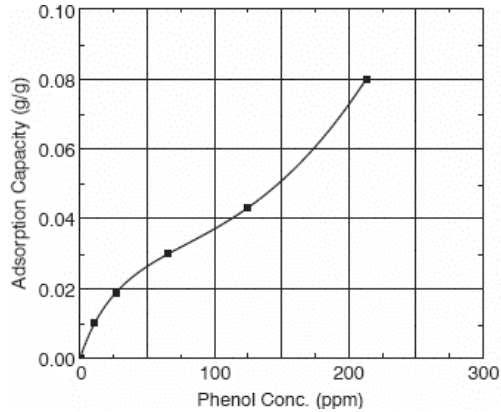

The isotherm data confirmed the feasibility of this separation, leading to the dynamic column study shown in Figure 4. A 200-ppm phenol solution at pH 6.0 was introduced into a column of DuPont™ AmberSorb™ L493 Polymeric Adsorbent at a flowrate of 8 bed volumes per hour. At 10% breakthrough the column had treated 160 bed volumes of feed.

The adsorbent was regenerated with 1N NaOH followed by a water rinse.

AmberSorb™ L493 can be desorbed or regenerated by a number of methods, depending on the nature of the compound and the process. Possible desorbents are aqueous acids or bases, organic solvents, or steam.

**Figure 4: Dynamic Column Study**

AmberSorb™ L493 Polymeric Adsorbent Phenol (200-ppm) in water @ pH 6.0

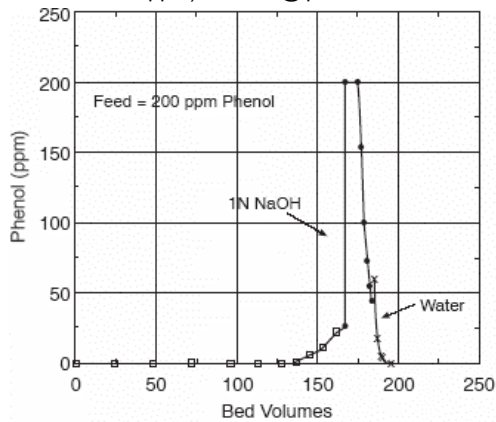

**Application Information (Cont.)**

**Gas Applications using DuPont™ AmberSorb™ V493 Polymeric Adsorbent**

AmberSorb™ V493 Polymeric Adsorbent exhibits high capacities for a variety of volatile organic compounds (VOC) and hazardous air pollutants (HAP). Some representative equilibrium adsorption isotherms obtained at ambient temperature are shown in Figure 5 – Figure 8.

**Figure 5: Equilibrium Adsorption Isotherm**

AmberSorb™ V493 Polymeric Adsorbent Vapor Phase: Perchloroethylene, Trichloroethylene, 1,1,1-Trichloroethane, Methylene chloride

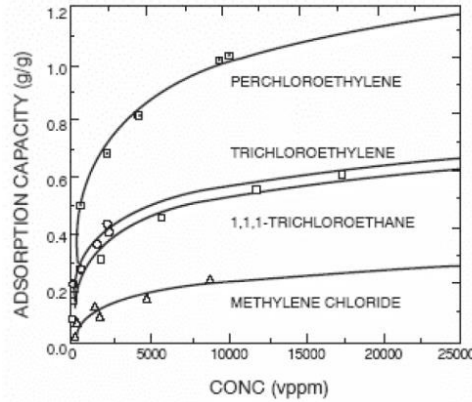

**Figure 6: Equilibrium Adsorption Isotherm**

AmberSorb™ V493 Polymeric Adsorbent Vapor Phase: Toluene, Xylene

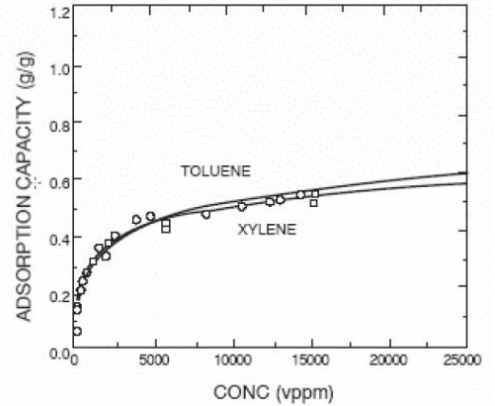

**Figure 7: Equilibrium Adsorption Isotherm**

AmberSorb™ V493 Polymeric Adsorbent Vapor Phase: Methyl ethyl ketone, Acetone

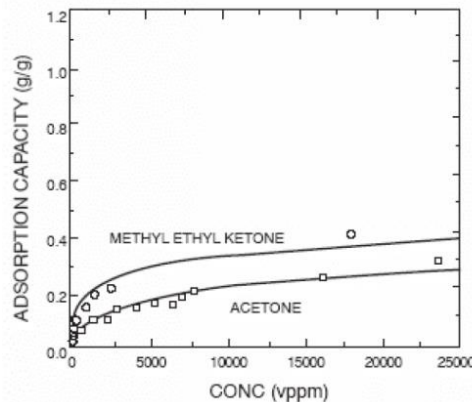

**Figure 8: Equilibrium Adsorption Isotherm**

AmberSorb™ V493 Polymeric Adsorbent Vapor Phase: Butyl acetate, Isopropyl alcohol, Methanol

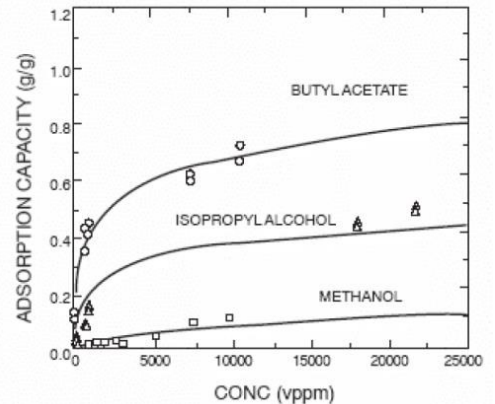

**Application Information (Cont.)**

Compared to activated carbon, DuPont™ AmberSorb™ V493 is more hydrophobic; therefore, it will be better suited than carbon for applications in high-humidity air streams. The equilibrium adsorption isotherms for both activated carbon and AmberSorb™ V493 are shown in Figure 9.

**Figure 9: Equilibrium Adsorption Isotherm**  
AmberSorb™ V493 Polymeric Adsorbent vs. Activated Carbon Water Vapor

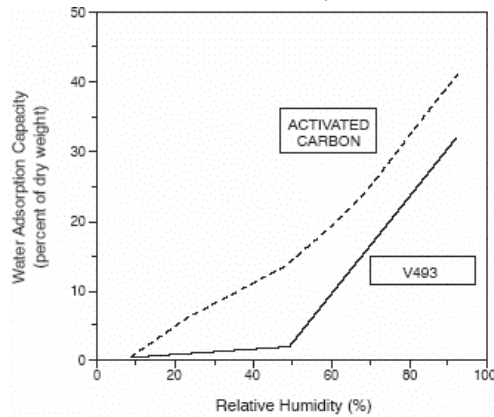

AmberSorb™ V493 can be desorbed or regenerated in a variety of ways, such as with steam, hot air or inert gas, vacuum, or combinations thereof.

For solvents that are immiscible with water, steam desorption may be the method of choice. Condensate can be collected and the organic and water phases separated by decantation. The resulting water phase can be air-stripped to remove residual organics, and the stripper vapor can be recycled to the adsorbent bed.

Hot gas desorption may be effectively used to regenerate AmberSorb™ V493. Desorption temperatures as high as 120°C may be safely used as long as some small quantity of cooling gas, presumably either air or nitrogen, is allowed to flow through the adsorbent bed. In most cases, a desorption temperature < 100°C will be adequate. The choice of air or nitrogen purge and the specific desorption temperature will depend on the particular solvents being desorbed, their concentrations, and their oxidative stability.

Vacuum desorption in a pressure swing adsorption process may also be practiced. In some cases, a combination of moderate vacuum and elevated temperature may be beneficially used to regenerate AmberSorb™ V493 Polymeric Adsorbent.

**Application Information (Cont.)**

Vacuum desorption is commercially practiced using indirect thermal and microwave heating as shown in Figure 10.

**Figure 10: Equipment Layout for Vacuum Swing Regeneration**

DuPont™ AmberSorb™ V493 Polymeric Adsorbent

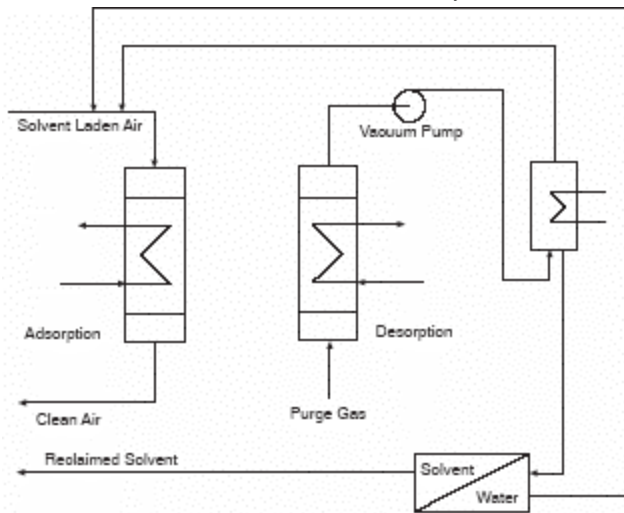

**Catalytic Activity**

In contrast to activated carbon, AmberSorb™ V493 Polymeric Adsorbent can be used to adsorb reactive solvents without catalyzing their decomposition. Reactive solvents such as acetone, methyl ethyl ketone, cyclohexanone, and styrene have been adsorbed and desorbed from AmberSorb™ V493 without measurable change in composition. With most activated carbons, however, measurable solvent degradation occurs. In extreme cases, solvent degradation on carbon beds can lead to an uncontrollable exotherm and a subsequent bed fire. The lack of catalytic decomposition when using AmberSorb™ V493 may be attributed to its extremely low mineral ash content.

**Product Stewardship**

DuPont has a fundamental concern for all who make, distribute, and use its products, and for the environment in which we live. This concern is the basis for our product stewardship philosophy by which we assess the safety, health, and environmental information on our products and then take appropriate steps to protect employee and public health and our environment. The success of our product stewardship program rests with each and every individual involved with DuPont products—from the initial concept and research, to manufacture, use, sale, disposal, and recycle of each product.

## Customer Notice

DuPont strongly encourages its customers to review both their manufacturing processes and their applications of DuPont products from the standpoint of human health and environmental quality to ensure that DuPont products are not used in ways for which they are not intended or tested. DuPont personnel are available to answer your questions and to provide reasonable technical support. DuPont product literature, including safety data sheets, should be consulted prior to use of DuPont products. Current safety data sheets are available from DuPont.

Please be aware of the following:

- **WARNING:** Oxidizing agents such as nitric acid attack organic ion exchange resins under certain conditions. This could lead to anything from slight resin degradation to a violent exothermic reaction (explosion). Before using strong oxidizing agents, consult sources knowledgeable in handling such materials.

Have a question? Contact us at:

[www.dupont.com/water/contact-us](http://www.dupont.com/water/contact-us)

All information set forth herein is for informational purposes only. This information is general information and may differ from that based on actual conditions. Customer is responsible for determining whether products and the information in this document are appropriate for Customer's use and for ensuring that Customer's workplace and disposal practices are in compliance with applicable laws and other government enactments. The product shown in this literature may not be available for sale and/or available in all geographies where DuPont is represented. The claims made may not have been approved for use in all countries. Please note that physical properties may vary depending on certain conditions and while operating conditions stated in this document are intended to lengthen product lifespan and/or improve product performance, it will ultimately depend on actual circumstances and is in no event a guarantee of achieving any specific results. DuPont assumes no obligation or liability for the information in this document. References to "DuPont" or the "Company" mean the DuPont legal entity selling the products to Customer unless otherwise expressly noted. NO WARRANTIES ARE GIVEN; ALL IMPLIED WARRANTIES OF MERCHANTABILITY OR FITNESS FOR A PARTICULAR PURPOSE ARE EXPRESSLY EXCLUDED. No freedom from infringement of any patent or trademark owned by DuPont or others is to be inferred.

© 2023 DuPont. DuPont™, the DuPont Oval Logo, and all trademarks and service marks denoted with ™, SM or ® are owned by affiliates of DuPont de Nemours Inc., unless otherwise noted.

